









Produktübersicht Traumatologie
Product Overview Traumatology



Surgical Innovation is our passion



Übersichtstafel
Table of Contents

KLS Martin Group Chirurgische Innovation ist unsere Leidenschaft Surgical Innovation is our passion		
Großfragment-System Large Fragment System		1-23
Kleinfragment-System Small Fragment System		25-43
Minifragment-System Mini Fragment System		45-61
Hohlschrauben-System Cannulated Screw System		63-69
Draht-Cerclage-System Wire Cerclage System		71-83
DMS/DMS Intermediate Das dynamische, winkeladaptierbare Laschensystem The dynamic, angle-adjustable Barrel Plate System		85-100

<p>Winkelplatten-System Angle Plates System</p>		<p>101-121</p>
<p>ISIS Integriertes Schulter-Implantat-System Integrated Shoulder Implant System</p>		<p>123-133</p>
<p>FOS Vorfuß- und Rückfuß-Osteosynthese-System Forefoot and Hindfoot Osteosynthesis System</p>		<p>135-148</p>
<p>Dynafix® Externer Fixateur External Fixator</p>		<p>149-158</p>
<p>Zubehör Accessories</p>		<p>159-169</p>
<p>Nummern-Index Index of order numbers</p>	<p>i</p>	<p>171-177</p>
<p>Index, alphabetisch, Deutsch Index, alphabetical, English</p>	<p>i</p>	<p>179-183</p>



Chirurgische Innovation

ist unsere Leidenschaft

Wie kommt man dazu, über 16.000 chirurgische Instrumente zu entwickeln, zu fertigen und zu vermarkten? Produkte, die sich durch klare Alleinstellungsmerkmale auszeichnen. Es ist die Leidenschaft, neue Wege zu finden, die Menschen helfen und der Gesundheit dienen.

Surgical Innovation is our passion

What is the secret behind the development, manufacture and distribution of over 16,000 exclusive surgical instruments, products whose distinguishing characteristics truly set them apart from all the others? The answer is passion, the overwhelming desire to discover new ways of serving humankind in its search for ultimate health.





Am Anfang stand die Vision, aus kleinen Firmen eine international agierende Unternehmensgruppe zu bilden. Das war 1923. Heute beschäftigt die KLS Martin Group über 1000 Mitarbeiter und ist einer der weltweit führenden Konzerne für Entwicklung, Produktion und Vertrieb medizintechnischer Produkte, die in enger Zusammenarbeit mit denjenigen entwickelt werden, die sie letztlich einsetzen: den Chirurgen.

In the beginning there was a vision

Our vision, in 1923, was to create an internationally operating group of companies from a handful of smaller businesses. Today, the KLS Martin Group has a staff of over 1000 and is one of the leading globally acting enterprises for the development, manufacture and distribution of medical devices. We work hand in hand with those holding the scalpel: the surgeon.

Am Anfang
stand eine Vision





Qualitätssicherung ohne Kompromisse

Unsere Produkte erfüllen den Anspruch anwendungsbezogener Funktionalität, intelligenter Handhabung und hoher Qualität. Und wenn es um die Erfüllung dieses Anspruchs geht, machen wir keine Kompromisse. Um dies zu gewährleisten, unterhält KLS Martin ein eigenes hochmodernes Labor sowie ein Technikum, in denen die Qualität unserer Erzeugnisse – auch unter extremen Bedingungen – auf „Herz und Nieren“ getestet und dokumentiert werden.

Quality assurance uncompromising

Our products are designed to consistently meet high demands for application-oriented functionality, intelligent operation and top quality. And we are not prepared to compromise when it comes to meeting the justified expectations of our customers, present and future – your standards become ours. KLS Martin runs their own ultramodern laboratories and a pilot plant, where our products are stress-tested under extreme conditions – every step is documented before release.

Wir setzen Standards

für die Instrumentenaufbereitung

Wie lassen sich Medizinprodukte vor mechanischer, thermischer oder chemischer Belastung schützen? Was muss man bei der Aufbereitung und Pflege besonders feingliedriger Mikrochirurgieinstrumente berücksichtigen? Als Mitglied wichtiger Gremien und Arbeitskreise – wie z. B. dem Arbeitskreis Instrumenten-Aufbereitung AKI – gibt KLS Martin Antworten und erarbeitet Lösungen für die optimale Aufbereitung und Pflege von Instrumenten. Von der Auswahl angemessener Reinigungsverfahren bis hin zu Sterilisationsverfahren.

Standards and best practice: instrument preparation

How best to protect surgical instruments from mechanical, thermal and chemical stresses? What steps are performed to ensure optimal preparation and care of highly delicate microsurgical instruments? KLS Martin, in their capacity as member of important advisory boards and working groups – for example, Working Group Instrument Preparation AKI – is in a position to provide answers and solutions to all inquiries with regard to the optimal preparation and care of instruments, ranging from knowledgeable advice on appropriate cleaning methods through sterilization processes.







Lebenslange Garantie
für MARTIN-Instrumente



Lebenslange Garantie – wann immer Sie sie brauchen

Keine Frage, wir sind stets auf der Suche nach der noch besseren Lösung. Das zeichnet den kontinuierlichen Fortschritt in unserem Produktportfolio aus. Gleichwohl sind alle unsere Instrumente qualitativ erstklassig und werden höchsten Ansprüchen gerecht. Und weil wir davon überzeugt sind, gewähren wir auf jedes Instrument bei sach- und fachgerechtem Einsatz eine lebenslange Garantie.

Whenever you need it – our lifetime guarantee

Our determined and ongoing search for the perfect solution is reflected in the dynamic nature of our product portfolio. You simply will not find better instruments on the market. And because we truly believe in the outstanding quality of our products, we offer a lifelong guarantee on each instrument, in connection with appropriate and professional use.



Großfragment-System
Large Fragment System

1-23

Schrauben, Großfragment-Sortiment

Screws, Large Fragment Portfolio

St

Edelstahl
Stainless steel

5

VE = Verpackungseinheit
SU = Quantity/pack

Kortikalisschraube Cortex screw

Ø 4,5 mm

St 5

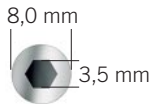

Länge Length	Art.-Nr. Item No.	selbstschneidend self-tapping
-----------------	----------------------	----------------------------------

14 mm	25-114-14-05	25-113-14-05
16 mm	25-114-16-05	25-113-16-05
18 mm	25-114-18-05	25-113-18-05
20 mm	25-114-20-05	25-113-20-05
22 mm	25-114-22-05	25-113-22-05
24 mm	25-114-24-05	25-113-24-05
26 mm	25-114-26-05	25-113-26-05
28 mm	25-114-28-05	25-113-28-05
30 mm	25-114-30-05	25-113-30-05
32 mm	25-114-32-05	25-113-32-05
34 mm	25-114-34-05	25-113-34-05
36 mm	25-114-36-05	25-113-36-05
38 mm	25-114-38-05	25-113-38-05
40 mm	25-114-40-05	25-113-40-05
42 mm	25-114-42-05	25-113-42-05
44 mm	25-114-44-05	25-113-44-05
46 mm	25-114-46-05	25-113-46-05
48 mm	25-114-48-05	25-113-48-05
50 mm	25-114-50-05	25-113-50-05
52 mm	25-114-52-05	25-113-52-05
54 mm	25-114-54-05	25-113-54-05
56 mm	25-114-56-05	25-113-56-05
58 mm	25-114-58-05	25-113-58-05
60 mm	25-114-60-05	25-113-60-05
62 mm	25-114-62-05	25-113-62-05
64 mm	25-114-64-05	25-113-64-05
66 mm	25-114-66-05	25-113-66-05
68 mm	25-114-68-05	25-113-68-05
70 mm	25-114-70-05	25-113-70-05
72 mm	25-114-72-05	25-113-72-05
74 mm	25-114-74-05	
76 mm	25-114-76-05	
80 mm	25-114-80-05	
85 mm	25-114-85-05	
90 mm	25-114-90-05	
95 mm	25-114-95-05	
100 mm	25-114-00-05	
105 mm	25-114-05-05	
110 mm	25-114-10-05	

Malleolarschrauben Malleolar screws

Ø 4,5 mm

St 5

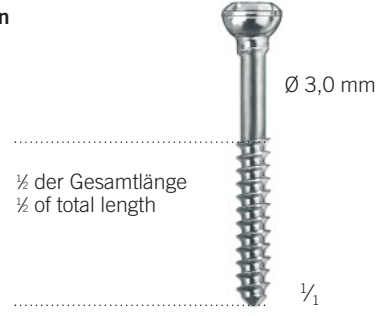
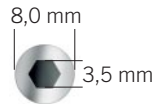

Länge Length	Art.-Nr. Item No.
-----------------	----------------------

20 mm	25-115-20-05
25 mm	25-115-25-05
30 mm	25-115-30-05
35 mm	25-115-35-05
40 mm	25-115-40-05
45 mm	25-115-45-05
50 mm	25-115-50-05
55 mm	25-115-55-05
60 mm	25-115-60-05
65 mm	25-115-65-05
70 mm	25-115-70-05
75 mm	25-115-75-05
80 mm	25-115-80-05
85 mm	25-115-85-05

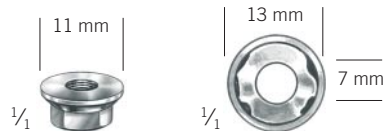

25-119-96-05

Mutter
Nut

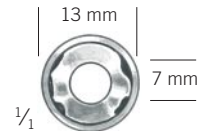

25-119-99-05

Unterlegscheibe
Washer



25-219-97-07



Schraubenpinzette, selbsthaltend
Screw forceps, self-retaining



56-520-00-04

Schraubenkassette, leer
Screw rack, empty



<p>Spongiaschrauben Cancellous screws</p> <p>Ø 6,5 mm</p> <p>St 5</p> <p>8,0 mm 3,5 mm</p>	<p>Gewindelänge Length of thread</p> <p>16 mm</p> 	<p>Gewindelänge Length of thread</p> <p>32 mm</p> 	<p>Vollgewinde Full thread</p> 
<p>Länge Length</p>	<p>Art.-Nr. Item No.</p>		
25 mm			25-118-25-05
30 mm	25-116-30-05		25-118-30-05
35 mm	25-116-35-05		25-118-35-05
40 mm	25-116-40-05		25-118-40-05
45 mm	25-116-45-05	25-117-45-05	25-118-45-05
50 mm	25-116-50-05	25-117-50-05	25-118-50-05
55 mm	25-116-55-05	25-117-55-05	25-118-55-05
60 mm	25-116-60-05	25-117-60-05	25-118-60-05
65 mm	25-116-65-05	25-117-65-05	25-118-65-05
70 mm	25-116-70-05	25-117-70-05	25-118-70-05
75 mm	25-116-75-05	25-117-75-05	25-118-75-05
80 mm	25-116-80-05	25-117-80-05	25-118-80-05
85 mm	25-116-85-05	25-117-85-05	25-118-85-05
90 mm	25-116-90-05	25-117-90-05	25-118-90-05
95 mm	25-116-95-05	25-117-95-05	25-118-95-05
100 mm	25-116-00-05	25-117-00-05	25-118-00-05
105 mm	25-116-05-05	25-117-05-05	25-118-05-05
110 mm	25-116-10-05	25-117-10-05	25-118-10-05
115 mm	25-116-15-05	25-117-15-05	
120 mm	25-116-20-05	25-117-20-05	

Platten, Großfragment-Sortiment

Plates, Large Fragment Portfolio

St

Edelstahl
Stainless steel

1

VE = Verpackungseinheit
SU = Quantity/pack



Nut
Groove

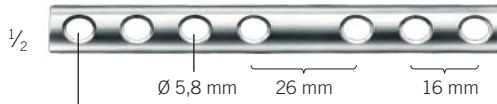
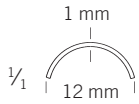

für Kortikalis- und Malleolarschrauben, Ø 4,5 mm
for cortical and malleolar screws, Ø 4.5 mm

Halbrohrplatten Semi-tubular plates

St 1

Länge Length	Löcher Holes	Art.-Nr. Item No.
39 mm	2	25-122-02-05
55 mm	3	25-122-03-05
71 mm	4	25-122-04-05
87 mm	5	25-122-05-05
103 mm	6	25-122-06-05
119 mm	7	25-122-07-05
135 mm	8	25-122-08-05
151 mm	9	25-122-09-05
167 mm	10	25-122-10-05
183 mm	11	25-122-11-05
199 mm	12	25-122-12-05

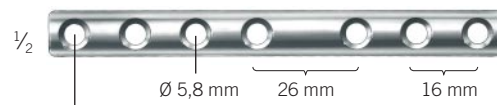
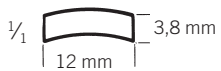

für Kortikalis- und Malleolarschrauben, Ø 4,5 mm
für Spongiosaschrauben, Ø 6,5 mm

for cortical and malleolar screws, Ø 4.5 mm
for cancellous screws, Ø 6.5 mm

Rundloch-Platten, schmal Round hole plates, narrow

St 1



Nut an beiden Enden
Groove at both ends

Länge Length	Löcher Holes	Art.-Nr. Item No.
39 mm	2	25-123-02-05
55 mm	3	25-123-03-05
71 mm	4	25-123-04-05
87 mm	5	25-123-05-05
103 mm	6	25-123-06-05
119 mm	7	25-123-07-05
135 mm	8	25-123-08-05
151 mm	9	25-123-09-05
167 mm	10	25-123-10-05
183 mm	11	25-123-11-05
199 mm	12	25-123-12-05
215 mm	13	25-123-13-05
231 mm	14	25-123-14-05
247 mm	15	25-123-15-05
263 mm	16	25-123-16-05
279 mm	17	25-123-17-05
295 mm	18	25-123-18-05



für Kortikalis- und Malleolarschrauben, Ø 4,5 mm
für Spongiaschrauben, Ø 6,5 mm

for cortical and malleolar screws, Ø 4.5 mm
for cancellous screws, Ø 6.5 mm

Kompressionsplatten, schmal
Compression plates, small

St 1



Nut an beiden Enden
Groove at both ends

Länge Length	Löcher Holes	Art.-Nr. Item No.
39 mm	2	25-124-02-05
55 mm	3	25-124-03-05
71 mm	4	25-124-04-05
87 mm	5	25-124-05-05
103 mm	6	25-124-06-05
119 mm	7	25-124-07-05
135 mm	8	25-124-08-05
151 mm	9	25-124-09-05
167 mm	10	25-124-10-05
183 mm	11	25-124-11-05
199 mm	12	25-124-12-05
215 mm	13	25-124-13-05
231 mm	14	25-124-14-05
247 mm	15	25-124-15-05
263 mm	16	25-124-16-05
295 mm	18	25-124-18-05

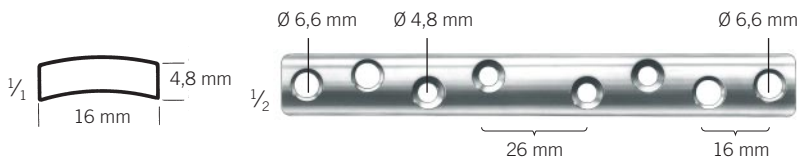

für Kortikalis- und Malleolarschrauben, Ø 4,5 mm
für Spongiaschrauben, Ø 6,5 mm

for cortical and malleolar screws, Ø 4.5 mm
for cancellous screws, Ø 6.5 mm

Rundloch-Platten, breit
Round hole plates, wide

St 1



Nut an beiden Enden
Groove at both ends

Länge Length	Löcher Holes	Art.-Nr. Item No.
103 mm	6	25-125-06-05
119 mm	7	25-125-07-05
135 mm	8	25-125-08-05
151 mm	9	25-125-09-05
167 mm	10	25-125-10-05
183 mm	11	25-125-11-05
199 mm	12	25-125-12-05
215 mm	13	25-125-13-05
231 mm	14	25-125-14-05
247 mm	15	25-125-15-05
263 mm	16	25-125-16-05
295 mm	18	25-125-18-05

Platten, Großfragment-Sortiment

Plates, Large Fragment Portfolio

St

Edelstahl
Stainless steel

1

VE = Verpackungseinheit
SU = Quantity/pack



Nut
Groove



für Kortikalis- und Malleolarschrauben, Ø 4,5 mm
für Spongiosaschrauben, Ø 6,5 mm

for cortical and malleolar screws, Ø 4.5 mm
for cancellous screws, Ø 6.5 mm

Kompressionsplatten, breit

Compression plates, wide

St 1



Nut an beiden Enden
Groove at both ends

Länge Length	Löcher Holes	Art.-Nr. Item No.
103 mm	6	25-126-06-05
119 mm	7	25-126-07-05
135 mm	8	25-126-08-05
151 mm	9	25-126-09-05
167 mm	10	25-126-10-05
183 mm	11	25-126-11-05
199 mm	12	25-126-12-05
215 mm	13	25-126-13-05
231 mm	14	25-126-14-05
247 mm	15	25-126-15-05
263 mm	16	25-126-16-05
295 mm	18	25-126-18-05

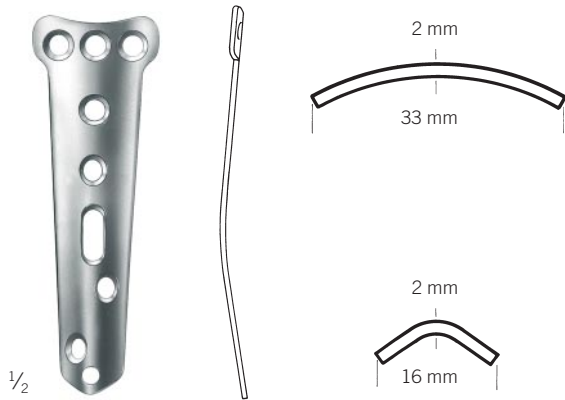

Schaft mit V-Profil für Fixation auf der vorderen Tibiakante
Shaft with V-profile for fixation on the front edge of the tibia

für Kortikalisschrauben, Ø 4,5 mm
for cortical screws, Ø 4.5 mm

Löffelplatten
Spoon plates

St 1

Länge Length	Löcher Holes	Art.-Nr. Item No.
100 mm	5	25-140-05-05
120 mm	6	25-140-06-05

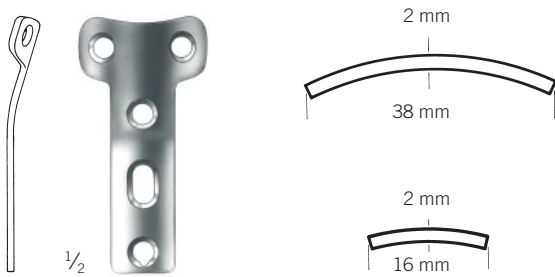

Schaft mit rundem Profil für Humerus- und Tibiakopf
Shaft with round profile for humeral and tibial heads

für Kortikalisschrauben, Ø 4,5 mm
for cortical screws, Ø 4.5 mm

T-Platten
T-Plates

St 1

Länge Length	Löcher Holes	Art.-Nr. Item No.
68 mm	3	25-140-13-05
84 mm	4	25-140-14-05
105 mm	5	25-140-15-05
116 mm	6	25-140-16-05
148 mm	8	25-140-18-05

Platten, Großfragment-Sortiment

Plates, Large Fragment Portfolio

St

Edelstahl
Stainless steel

1

VE = Verpackungseinheit
SU = Quantity/pack

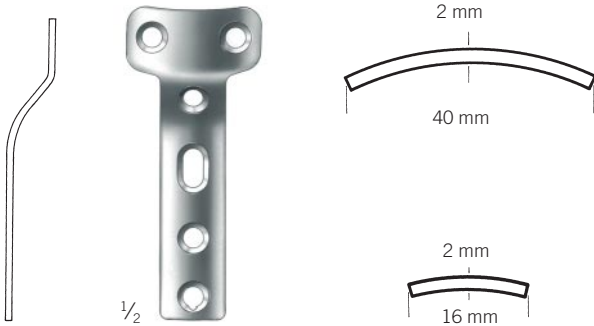

T-Abstützplatten T-Buttruss plates

St 1

Länge Length	Löcher Holes	Art.-Nr. Item No.
80 mm	4	25-140-34-05
103 mm	5	25-140-35-05
116 mm	6	25-140-36-05

Indikation: zur Abstützung des Tibiakopfes
Indication: for buttressing the tibial head

für Kortikalisschrauben, Ø 4,5 mm
for cortical screws, Ø 4.5 mm

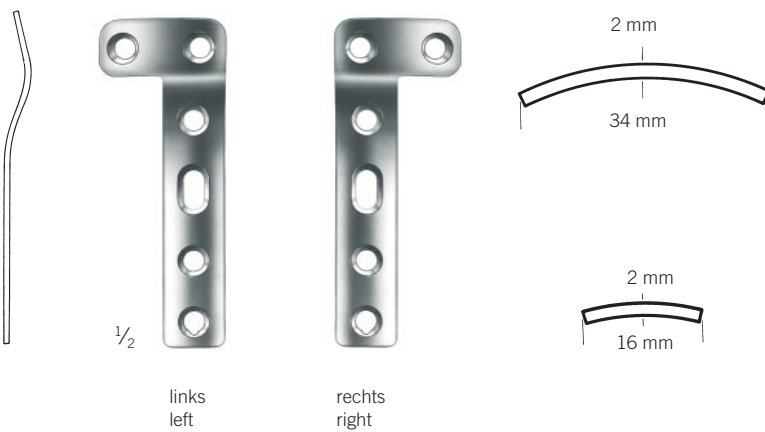

L-Abstützplatten L-Buttruss plates

St 1

Länge Length	Löcher Holes	Art.-Nr. Item No.
Links/left		
87 mm	4	25-140-44-05
Rechts/right		
87 mm	4	25-140-54-05

Indikation: zur Abstützung des Tibiakopfes
Indication: for buttressing the tibial head

für Kortikalisschrauben, Ø 4,5 mm
for cortical screws, Ø 4.5 mm

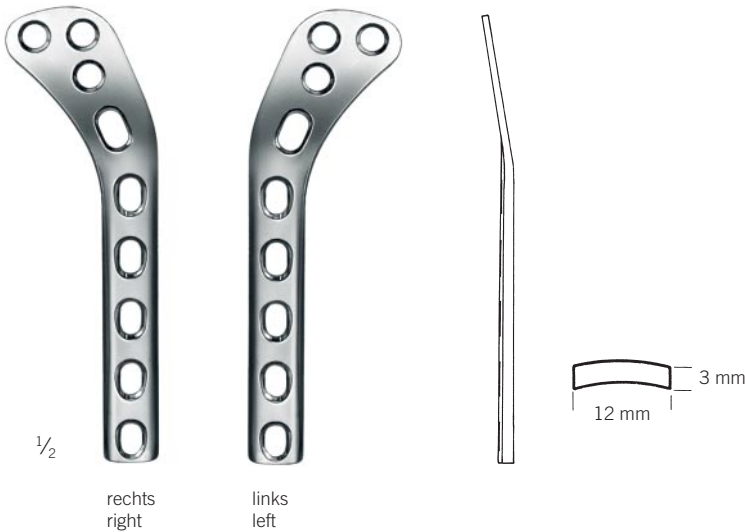

Indikation: zur Abstützung des Tibiakopfes
Indication: for buttressing the tibial head

für Kortikalis- und Malleolarschrauben, Ø 4,5 mm
für Spongiaschrauben, Ø 6,5 mm

for cortical and malleolar screws, Ø 4.5 mm
for cancellous screws, Ø 6.5 mm

Tibia-Abstützplatten, lateral
Tibia buttress plates, lateral



Länge Length	Löcher Holes	Art.-Nr. Item No.
Rechts/right		
119 mm	5	25-140-46-05
151 mm	7	25-140-47-05
183 mm	9	25-140-48-05
215 mm	11	25-140-49-05
247 mm	11	25-140-50-05
Links/left		
119 mm	5	25-140-56-05
151 mm	7	25-140-57-05
183 mm	9	25-140-58-05
215 mm	11	25-140-59-05
247 mm	11	25-140-60-05

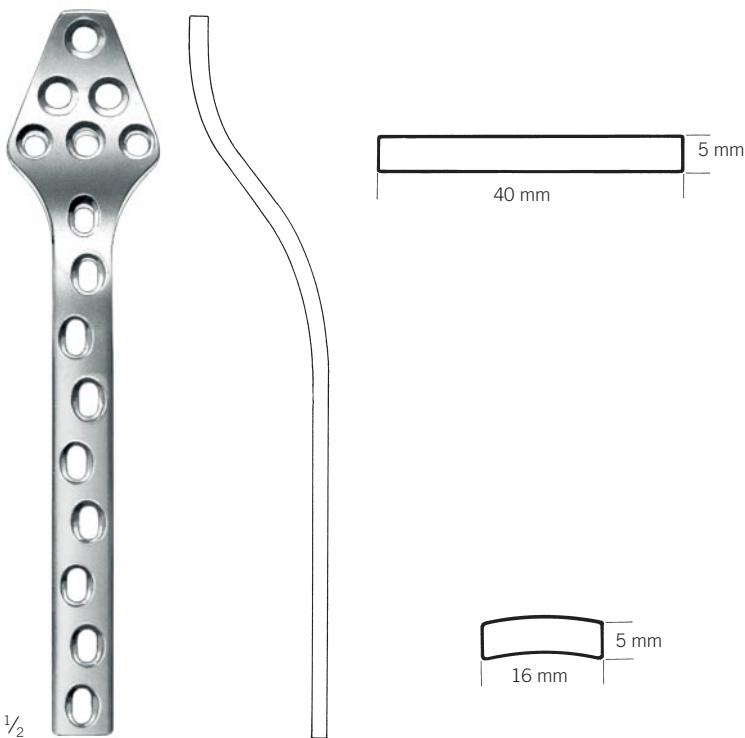

Indikation: für Hüftarthrose
Indication: for hip arthrosis

für Kortikalis- und Malleolarschrauben, Ø 4,5 mm
für Spongiaschrauben, Ø 6,5 mm

for cortical and malleolar screws, Ø 4.5 mm
for cancellous screws, Ø 6.5 mm

Kreuzplatten
Special hip compression plates



Länge Length	Löcher Holes	Art.-Nr. Item No.
170 mm	8	25-140-98-05
186 mm	9	25-140-99-05
202 mm	10	25-140-90-05
218 mm	11	25-140-91-05

Instrumente, Großfragment-Sortiment

Instruments, Large Fragment Portfolio



mit AO-Ansatz
with AO attachment

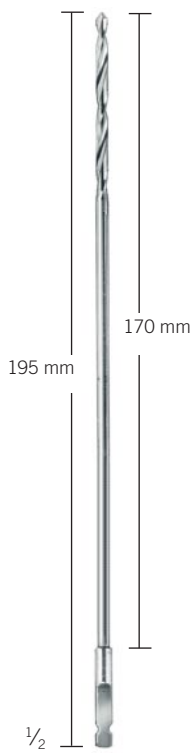

25-210-30-07 
Ø 3,2 mm
Spiralbohrer
Drill bits



25-210-31-07 
Ø 3,2 mm



25-210-44-07 
Ø 4,5 mm



25-210-96-07 
12 cm / 4 3/4"
Ø 3,2 mm
Kopfraumfräser für
Malleolarschrauben
Malleolar countersink
for malleolar screws



25-210-99-07
18 cm / 7"
Ø 4,5 mm
Kopfraumfräser
Countersink for
malleolar screws



1/2



25-211-44-07
8,5 cm / 3 1/2"
T-Griffstück für AO-Ansatz
T-handle for AO attachment

1/2



25-211-45-07 ⚙️
13 cm / 5"
Ø 4,5 mm
Gewindeschneider, kurz
Tap, short

1/2



25-211-46-07 ⚙️
13 cm / 5"
Ø 4,5 mm
Gewindeschneider, lang
Tap, long

1/2



25-211-48-07 ⚙️
18 cm / 7 1/2"
Ø 4,5 mm
Gewindeschneider, extra lang
Tap, extra long

1/2



25-211-66-07 ⚙️
20 cm / 8"
Ø 6,5 mm
Gewindeschneider
Tap



für Bohrer Ø 3,5 mm
 for drill bit Ø 3.5 mm

1/2

25-212-26-01
 11 cm / 4 1/2"
 Gewebeschutzhülse
 Soft-tissue sleeve



für Bohrer Ø 3,2 mm
 for drill bit Ø 3.2 mm

1/2

25-212-32-01
 5 cm / 2"
 Steckbohrbüchse für 25-212-45-01
 Drill bit sleeve for 25-212-45-01



Ø 4,5 mm

1/2

25-212-45-01
 14,5 cm / 5 3/4"
 Gewebeschutzhülse
 Soft-tissue sleeve



1/2

25-212-47-01
 15 cm / 6"
 Zielgerät für 25-212-45-01
 Drill bit guide for 25-212-45-01



mit AO-Ansatz
with AO attachment



Ferrozell



1/2

22-368-35-07 

25 cm / 9 7/8"

Ø 3,5 mm

Schraubendreher

Screw driver



1/2

25-214-15-07 

11,5 cm / 4 1/2"

Ø 3,5 mm

Schraubendreher-Einsatz

Screwdriver bit



1/2

25-214-21-07

12 cm / 4 5/8"

Schlüssel für Unterlegscheibe

Wrench for washer



1/2

25-219-05-07

22 cm / 8 3/4"

Tiefenmesser, groß

Depth gauge, large



1/2

25-219-39-07

15,5 cm / 6"

Scharfer Haken

Sharp hook

für Bohrer Ø 3,2 mm
 for drill bit Ø 3.2 mm



25-221-01-01

5 cm / 2"

Bohrlehre für Plattenspanner
 für Bohrer Ø 3,2 mm, Spannweg 8/16

Drill bit sleeve for plate tensioner
 for drill bit Ø 3,2 mm, span 8/16



für Bohrer Ø 3,2 mm
 for drill bit Ø 3.2 mm

25-221-04-01

11,5 cm / 4 1/2"

Bohrlehre für Rund- und
 Halbrohrplatten

Drill bit sleeve for round-hole
 and semitubular plates



25-221-10-07

6 cm / 2 1/2"

Plattenspanner, Spannweg 8 mm
 Plate tensioner, span 8 mm



25-221-12-07

9 cm / 3 1/2"

Plattenspanner, Spannweg 20 mm
 Plate tensioner, span 20 mm



25-221-15-07
18,5 cm / 7 1/2"
Kardanschlüssel 11 mm
Cardan wrench 11 mm



25-221-17-07
15 cm / 6"
Gabelschlüssel 11 mm
Open-ended wrench 11 mm

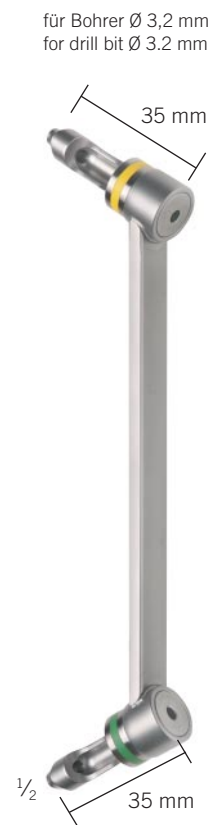

für Bohrer Ø 3,2 mm
for drill bit Ø 3.2 mm
25-222-44-01
16,5 cm / 6 1/2"
Bohrlehre, neutral und exzentrisch
Drill bit guide, neutral and eccentric



25-229-45-01
Biegeschablone 5-Loch
Bending templates 5-holes



25-229-47-01
Biegeschablone 7-Loch
Bending templates 7-holes



25-229-49-01
Biegeschablone 9-Loch
Bending templates 9-holes



25-229-20-07
Biegezange
Plate bending pliers



25-229-02-07
24 cm / 7 1/2"
Schränkeisen für Standard-Platten
Bending iron for standard plates



25-229-30-07
Biegepresse
Bending press

Schrauben, Großfragment-Set

Screws, Large Fragment Set

St

Edelstahl
Stainless steel

5

VE = Verpackungseinheit
SU = Quantity/pack



25-100-01-04

Schrauben, Großfragment-Set, komplett
Screws, Large Fragment Set, complete

Kortikalisschraube Cortex screw			Ø 4,5 mm	St	5
Art.-Nr. Item No.	Länge Length	Stückzahl/Set Quantity/set			
25-114-14-05	14 mm	5			
25-114-16-05	16 mm	5			
25-114-18-05	18 mm	5			
25-114-20-05	20 mm	5			
25-114-22-05	22 mm	5			
25-114-24-05	24 mm	5			
25-114-26-05	26 mm	5			
25-114-28-05	28 mm	5			
25-114-30-05	30 mm	15			
25-114-32-05	32 mm	10			
25-114-34-05	34 mm	10			
25-114-36-05	36 mm	10			
25-114-38-05	38 mm	10			
25-114-40-05	40 mm	10			
25-114-42-05	42 mm	5			
25-114-44-05	44 mm	10			
25-114-46-05	46 mm	5			
25-114-48-05	48 mm	5			
25-114-50-05	50 mm	5			
25-114-52-05	52 mm	5			
25-114-56-05	56 mm	5			
25-114-60-05	60 mm	5			
25-114-64-05	64 mm	5			
25-114-70-05	70 mm	5			

Malleolarschraube Malleolar screw			Ø 4,5 mm	St	5
Art.-Nr. Item No.	Länge Length	Stückzahl/Set Quantity/set			
25-115-25-05	25 mm	5			
25-115-30-05	30 mm	5			
25-115-35-05	35 mm	5			
25-115-40-05	40 mm	5			
25-115-45-05	45 mm	5			
25-115-50-05	50 mm	5			
25-115-55-05	55 mm	5			
25-115-60-05	60 mm	5			
25-115-65-05	65 mm	5			
25-115-70-05	70 mm	5			

Spongiosaschraube Concellous bone screw			Ø 4,5 mm	St	5
Art.-Nr. Item No.	Länge Length	Stückzahl/Set Quantity/set			
Teilgewinde / Partial Thread 16 mm					
25-116-30-05	30 mm	5			
25-116-35-05	35 mm	5			
25-116-40-05	40 mm	5			
25-116-45-05	45 mm	5			
25-116-50-05	50 mm	5			
25-116-55-05	55 mm	5			
25-116-60-05	60 mm	5			
25-116-65-05	65 mm	5			
25-116-70-05	70 mm	5			
25-116-75-05	75 mm	5			
25-116-80-05	80 mm	5			
25-116-85-05	85 mm	5			
25-116-90-05	90 mm	5			
25-116-95-05	95 mm	5			
25-116-00-05	100 mm	5			
25-116-05-05	105 mm	5			
25-116-10-05	110 mm	5			
Teilgewinde / Partial Thread 32 mm					
25-117-45-05	30 mm	5			
25-117-50-05	35 mm	5			
25-117-55-05	40 mm	5			
25-117-60-05	45 mm	5			
25-117-65-05	50 mm	5			
25-117-70-05	55 mm	5			
25-117-80-05	60 mm	5			
25-117-90-05	65 mm	5			
Vollgewinde / Full Thread					
25-118-25-05	30 mm	5			
25-118-30-05	35 mm	5			
25-118-35-05	40 mm	5			
25-118-40-05	45 mm	5			



55-440-15-04
300 x 300 x 160 mm
MicroStop®-Container
MicroStop® container

Lagerung Storage

Art.-Nr. Item No.	Stückzahl/Set Quantity/set	VE SU	Bezeichnung	Designation
55-440-15-04	1	①	MicroStop®-Container 300 x 300 x 160 mm	MicroStop® container 300 x 300 x 160 mm
55-443-12-04	2	①	Farbreiter, rot	Color tag, red
55-443-22-04	2	①	Codierschild mit Beschriftung	Coding label, lettered
56-520-00-01	1	①	Schraubenkassette, leer	Screw rack, empty
55-996-55-04	1	①	Abdecktuch, OP-Grün, 1000 x 1000 mm	Covering towel, OR-green, 1000 x 1000 mm

Verschiedenes Miscellaneous

Art.-Nr. Item No.	Stückzahl/Set Quantity/set	VE SU	Bezeichnung	Designation
25-119-96-05	6	①	Mutter für Schrauben, Ø 4,5 mm	Nut for screws, Ø 4.5 mm
25-119-99-05	6	①	Unterlegscheibe, 13 mm	Washer, 13 mm
25-219-97-07	1	①	Schraubenfasspinzette, selbsthaltend	Screw forceps, self-retaining

Platten, Großfragment-Set

Plates, Large Fragment Set

St

Edelstahl
Stainless steel

1

VE = Verpackungseinheit
SU = Quantity/pack



25-100-02-04

Platten, Großfragment-Set, komplett
Plates, Large Fragment Set, complete

Art.-Nr. Item No.	Länge Length	Lochzahl Holes	Stückzahl/Set Quantity/set
Halbrohrplatte Semi-tubular plate			St 1
25-122-04-05	71 mm	4	2
25-122-05-05	87 mm	5	2
25-122-06-05	103 mm	6	2
25-122-07-05	119 mm	7	1
Schmale Kompressionsplatte Narrow compression plate			St 1
25-124-04-05	71 mm	4	2
25-124-05-05	87 mm	5	2
25-124-06-05	103 mm	6	4
25-124-07-05	119 mm	7	2
25-124-08-05	135 mm	8	2
25-124-09-05	151 mm	9	2
25-124-10-05	167 mm	10	1
25-124-12-05	199 mm	12	1
Breite Kompressionsplatte Wide compression plate			St 1
25-126-06-05	103 mm	6	2
25-126-07-05	119 mm	7	2
25-126-08-05	135 mm	8	2
25-126-09-05	151 mm	9	1
25-126-10-05	167 mm	10	1
25-126-12-05	199 mm	12	1
25-126-14-05	231 mm	14	1

Art.-Nr. Item No.	Länge Length	Lochzahl Holes	Stückzahl/Set Quantity/set
Löffelplatte Spoon Plate			St 1
25-140-05-05	100 mm	5	1
25-140-06-05	120 mm	6	1
T-Platte T-Plate			St 1
25-140-14-05	84 mm	4	1
25-140-16-05	116 mm	6	1
25-140-18-05	148 mm	8	1
T-Abstützplatte T-Buttress Plate			St 1
25-140-34-05	80 mm	4	1
L-Abstützplatte L-Buttress Plate			St 1
25-140-44-05	87 mm	4	1
25-140-54-05	87 mm	4	1



55-440-15-04
300 x 300 x 160 mm
MicroStop®-Container
MicroStop® container

Lagerung Storage				
Art.-Nr. Item No.	Stückzahl/Set Quantity/set	VE SU	Bezeichnung	Designation
55-440-15-04	1	①	MicroStop®-Container 300 x 300 x 160 mm	MicroStop® container 300 x 300 x 160 mm
55-443-12-04	2	①	Farbreiter, rot	Color tag, red
55-443-22-04	2	①	Codierschild mit Beschriftung	Coding label, lettered
55-805-24-01	1	①	Siebkorb 1/2, 243 x 255 x 33 mm	Mesh tray 1/2, 243 x 255 x 33 mm
55-805-25-01	1	①	Siebkorb 1/2, 243 x 255 x 53 mm	Mesh tray 1/2, 243 x 255 x 53 mm
55-807-24-04	2	①	Noppenmatte, 234 x 244 mm	Silicone mat, 234 x 244 mm
55-996-55-04	1	①	Abdecktuch, OP-Grün, 1000 x 1000 mm	Covering towel, OR-green, 1000 x 1000 mm

Instrumente, Großfragment-Set

Instruments, Large Fragment Set

St

Edelstahl
Stainless steel

5

VE = Verpackungseinheit
SU = Quantity/pack



25-100-03-04

Instrumente, Großfragment-Set, komplett
Instruments, Large Fragment Set, complete

25-100-03-04			Instrumente, Großfragment-Set, komplett, bestehend aus:	Instruments, Large Fragment Set, complete, consisting of:
Art.-Nr. Item No.	Stückzahl/Set Quantity/set	VE SU	Bezeichnung	Designation
22-368-35-07	1	1	Schraubendreher Inbus 3,5 mm	Screwdriver, 3.5 mm, hexagon
25-210-31-07	3	1	Spiralbohrer Ø 3,2 mm	Drill bit Ø 3.2 mm
25-210-44-07	2	1	Spiralbohrer Ø 4,5 mm	Drill bit Ø 4.5 mm
25-210-96-07	1	1	Kopfraumfräser Ø 3,2 mm	Countersink Ø 3.2 mm
25-210-99-07	1	1	Kopfraumfräser Ø 4,5 mm	Countersink Ø 4.5 mm
25-211-44-07	1	1	T-Handgriffstück AO-Kupplung	Tap handle with AO attachment
25-211-45-07	2	1	Gewindeschneider Ø 4,5 mm, kurz	Tap Ø 4.5 mm, short
25-211-46-07	2	1	Gewindeschneider Ø 4,5 mm, lang	Tap Ø 4.5 mm, long
25-211-66-07	1	1	Gewindeschneider Ø 6,5 mm	Tap Ø 6.5 mm
25-212-26-01	1	1	Gewebeschutzhülse Ø 3,5 mm	Tap sleeve Ø 3.5 mm
25-212-32-01	1	1	Steckbohrbüchse, 4,5/3,2 mm	Insert drill sleeve 4.5/3.2 mm
25-212-45-01	1	1	Gewebeschutzhülse Ø 4,5 mm	Tap sleeve Ø 4.5 mm
25-212-47-01	1	1	Zielgerät mit Spitze für 25-212-45-01	Pointed drill guide for 25-212-45-01
25-214-15-07	1	1	Schraubendrehereinsatz Inbus 3,5 mm	Shaft for screwdriver hexadrive 3.5 mm
25-214-21-07	1	1	Schlüssel für Unterlegscheibe	Nutkey SW 08
25-219-05-07	1	1	Schraubenmessgerät groß	Depth gauge for large screws
25-219-39-07	1	1	Scharfer Haken	Sharp hook
25-221-01-01	1	1	Bohrlehre für Plattenspanner, Ø 3,2 mm	Drill sleeve for tension device, Ø 3.2 mm
25-221-04-01	1	1	Bohrbuchse Ø 3,2 mm	Drill guide Ø 3.2 mm for plates 40 mm
25-221-10-07	1	1	Plattenspanner, Spannweg 8 mm	Tension device, 8 mm span
25-221-12-07	1	1	Plattenspanner, Spannweg 20 mm	Tension device, 20 mm span
25-221-15-07	1	1	Kardanschlüssel Ø 11 mm	Socket wrench Ø 11 mm
25-221-17-07	1	1	Gabelschlüssel Ø 11 mm	Wrench Ø 11 mm
25-222-44-01	1	1	Bohrlehre Ø 3,2 mm, neutral und exzentrisch	Drill guide Ø 3.2 mm, neutral and eccentric
25-229-02-07	2	1	Schränkeisen	Bending iron for standard plates
25-229-30-07	1	1	Biegepresse	Bending press
25-229-45-01	1	1	Biegeschablone, 5-Loch, 9 cm	Bending templates, 5-hole, 9 cm
25-229-47-01	1	1	Biegeschablone, 7-Loch, 15 cm	Bending templates, 7-hole, 15 cm
25-229-49-01	1	1	Biegeschablone, 9-Loch, 18 cm	Bending templates, 9-hole, 18 cm



55-442-10-04
600 x 300 x 110 mm
MicroStop®-Container
MicroStop® container

Lagerung Storage				
Art.-Nr. Item No.	Stückzahl/Set Quantity/set	VE SU	Bezeichnung	Designation
55-442-10-04	1	①	MicroStop®-Container 272 x 553 x 122 mm	MicroStop® container 272 x 553 x 122 mm
55-443-12-04	2	①	Farbreiter, rot	Color tag, red
55-443-22-04	2	①	Codierschild mit Beschriftung	Coding label, lettered
55-805-49-01	1	①	Siebkorb DIN, 480 x 255 x 53 mm	Sterilization tray DIN, 480 x 255 x 53 mm
55-806-02-04	2	⑩	Clip, allein für Fixierelement	Clip, only for fixation element
55-806-51-04	8	①	Trennwand, Siebkorb, 123 x 9 x 40 mm	Partition wall, tray, 123 x 9 x 40 mm
55-996-57-04	1	①	Abdecktuch, OP-Grün, 1000 x 1000 mm	Covering towel, OR-green, 1000 x 1000 mm



Kleinfragment-System
Small Fragment System

25-43

Schrauben, Kleinfragment-Sortiment

Screws, Small Fragment Portfolio

St

Edelstahl
Stainless steel

Ti

Titan
Titanium

5

VE = Verpackungseinheit
SU = Quantity/pack

Kortikalisschraube Cortex screw

Ø 3,5 mm

St 5

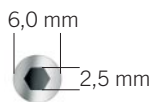

Länge Length	selbstschneidend self-tapping	standard standard
8 mm		25-104-08-05
10 mm	25-103-10-05	25-104-10-05
12 mm	25-103-12-05	25-104-12-05
14 mm	25-103-14-05	25-104-14-05
16 mm	25-103-16-05	25-104-16-05
18 mm	25-103-18-05	25-104-18-05
20 mm	25-103-20-05	25-104-20-05
22 mm	25-103-22-05	25-104-22-05
24 mm	25-103-24-05	25-104-24-05
26 mm	25-103-26-05	25-104-26-05
28 mm	25-103-28-05	25-104-28-05
30 mm	25-103-30-05	25-104-30-05
32 mm	25-103-32-05	25-104-32-05
34 mm	25-103-34-05	25-104-34-05
36 mm	25-103-36-05	25-104-36-05
38 mm	25-103-38-05	25-104-38-05
40 mm	25-103-40-05	25-104-40-05
45 mm	25-103-45-05	25-104-45-05
50 mm	25-103-50-05	25-104-50-05
55 mm	25-103-55-05	25-104-55-05
60 mm	25-103-60-05	25-104-60-05
65 mm		25-104-65-05
70 mm	25-103-70-05	25-104-70-05
75 mm		25-104-75-05
80 mm		25-104-80-05
85 mm		25-104-85-05
90 mm		25-104-90-05
95 mm		25-104-95-05

Spongiaschraube Cancellous screw

Ø 3,5 mm

St 5

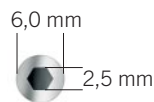

Gewindesteigung Thread pitch

1,75 mm

Länge Length	selbstschneidend self-tapping	standard standard
8 mm		25-106-08-05
10 mm		25-106-10-05
12 mm		25-106-12-05
14 mm	25-105-14-05	25-106-14-05
16 mm	25-105-16-05	25-106-16-05
18 mm	25-105-18-05	25-106-18-05
20 mm	25-105-20-05	25-106-20-05
22 mm	25-105-22-05	25-106-22-05
24 mm	25-105-24-05	25-106-24-05
26 mm	25-105-26-05	25-106-26-05
28 mm	25-105-28-05	25-106-28-05
30 mm	25-105-30-05	25-106-30-05
32 mm	25-105-32-05	25-106-32-05
34 mm	25-105-34-05	25-106-34-05
36 mm	25-105-36-05	25-106-36-05
38 mm	25-105-38-05	25-106-38-05
40 mm	25-105-40-05	25-106-40-05
42 mm	25-105-42-05	25-106-42-05
44 mm	25-105-44-05	25-106-44-05
45 mm	25-105-45-05	25-106-45-05
48 mm		25-106-48-05
50 mm	25-105-50-05	25-106-50-05
55 mm		25-106-55-05
60 mm		25-106-60-05
65 mm		25-106-65-05



Combi-Drive

Kortikalisschraube
Cortex screw

Ø 3,5 mm

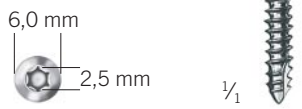

Länge
Length

selbstschneidend
self-tapping

10 mm	26-103-10-09
11 mm	26-103-11-09
12 mm	26-103-12-09
13 mm	26-103-13-09
14 mm	26-103-14-09
15 mm	26-103-15-09
16 mm	26-103-16-09
17 mm	26-103-17-09
18 mm	26-103-18-09
19 mm	26-103-19-09
20 mm	26-103-20-09
22 mm	26-103-22-09
24 mm	26-103-24-09
26 mm	26-103-26-09
28 mm	26-103-28-09
30 mm	26-103-30-09
32 mm	26-103-32-09
34 mm	26-103-34-09
36 mm	26-103-36-09
38 mm	26-103-38-09
40 mm	26-103-40-09
42 mm	26-103-42-09
44 mm	26-103-44-09

Spongiaschraube
Cancellous screw

Ø 3,5 mm

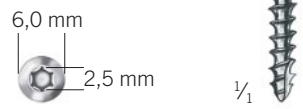

Länge
Length

selbstschneidend
self-tapping

10 mm	26-105-10-09
11 mm	26-105-11-09
12 mm	26-105-12-09
13 mm	26-105-13-09
14 mm	26-105-14-09
15 mm	26-105-15-09
16 mm	26-105-16-09
17 mm	26-105-17-09
18 mm	26-105-18-09
19 mm	26-105-19-09
20 mm	26-105-20-09
22 mm	26-105-22-09
24 mm	26-105-24-09
26 mm	26-105-26-09
28 mm	26-105-28-09
30 mm	26-105-30-09
32 mm	26-105-32-09
34 mm	26-105-34-09
36 mm	26-105-36-09
38 mm	26-105-38-09
40 mm	26-105-40-09
42 mm	26-105-42-09
44 mm	26-105-44-09

Schrauben und Platten, Kleinfragment-Sortiment

Screws and Plates, Small Fragment Portfolio

St

Edelstahl
Stainless steel

Ti

Titan
Titanium

5

VE = Verpackungseinheit
SU = Quantity/pack

Spongiaschraube
Cancellous screw

Ø 4,0 mm

St **5**

6,0 mm
2,5 mm

Teilgewinde
Partial thread

Teilgewinde
Partial thread

1/1

Länge Length	Gewindelänge Length of thread	selbstschneidend self-tapping	standard standard
10 mm	5 mm		25-107-10-05
12 mm	5 mm		25-107-12-05
14 mm	5 mm		25-107-14-05
16 mm	6 mm	25-108-16-05	25-107-16-05
18 mm	7 mm	25-108-18-05	25-107-18-05
20 mm	8 mm	25-108-20-05	25-107-20-05
22 mm	9 mm	25-108-22-05	25-107-22-05
24 mm	10 mm	25-108-24-05	25-107-24-05
26 mm	12 mm	25-108-26-05	25-107-26-05
28 mm	14 mm	25-108-28-05	25-107-28-05
30 mm	14 mm	25-108-30-05	25-107-30-05
35 mm	14 mm	25-108-35-05	25-107-35-05
40 mm	14 mm	25-108-40-05	25-107-40-05
45 mm	15 mm	25-108-45-05	25-107-45-05
50 mm	15 mm	25-108-50-05	25-107-50-05

Spongiaschraube
Cancellous screw

Ø 4,0 mm

St **5**

6,0 mm
2,5 mm

Vollgewinde
Full thread

1/1

Länge Length	selbstschneidend self-tapping	standard standard
10 mm	25-119-10-05	25-109-10-05
12 mm	25-119-12-05	25-109-12-05
14 mm	25-119-14-05	25-109-14-05
16 mm	25-119-16-05	25-109-16-05
18 mm	25-119-18-05	25-109-18-05
20 mm	25-119-20-05	25-109-20-05
22 mm	25-119-22-05	25-109-22-05
24 mm	25-119-24-05	25-109-24-05
26 mm	25-119-26-05	25-109-26-05
28 mm	25-119-28-05	25-109-28-05
30 mm	25-119-30-05	25-109-30-05
35 mm	25-119-35-05	25-109-35-05
40 mm	25-119-40-05	25-109-40-05
45 mm	25-119-45-05	25-109-45-05
50 mm	25-119-50-05	25-109-50-05
55 mm	25-119-55-05	25-109-55-05
60 mm	25-119-60-05	25-109-60-05

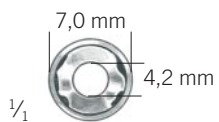

25-119-98-05

Unterlegscheibe
Washer

56-535-00-04

Lagerungsrack Kleinfragment, leer
Small fragment rack, empty

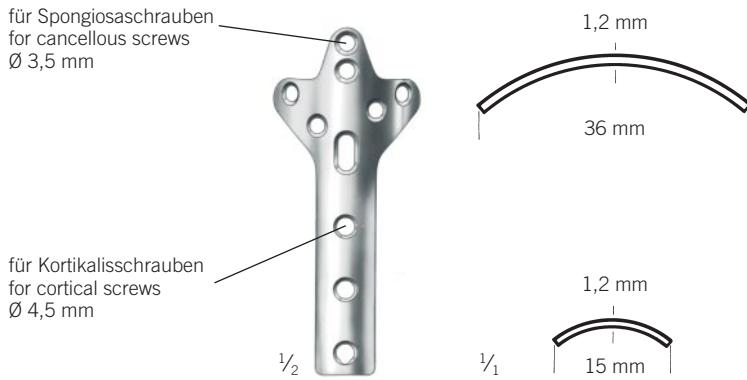

Kleeblatt-Platten
Cloverleaf plates

St 1

Länge Length	Löcher Holes	Art.-Nr. Item No.
88 mm	3	25-140-23-05
105 mm	4	25-140-24-05

Indikation: für distale intra-artikuläre Tibiafrakturen
Indication: for distal, intra-articular fractures of the tibia

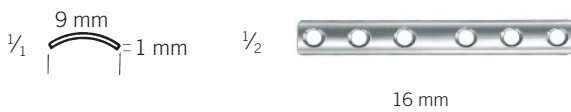

Drittelrohrplatten
One-third tubular plates

St 1

Länge Length	Löcher Holes	Art.-Nr. Item No.
25 mm	2	25-141-02-05
37 mm	3	25-141-03-05
49 mm	4	25-141-04-05
61 mm	5	25-141-05-05
73 mm	6	25-141-06-05
85 mm	7	25-141-07-05
97 mm	8	25-141-08-05
109 mm	9	25-141-09-05
121 mm	10	25-141-10-05
145 mm	12	25-141-12-05

Indikation: Für Fibula, Mittelhand- und Mittelfußknochen als Abstützplatte.
Kompressionswirkung durch exzentrisches, frakturfernes Einsetzen der Schrauben möglich.

Indication: Supporting plate for fibula, metacarpal and metatarsal bone.
Compression through eccentric screw insertion at a distance from the fracture.

Platten, Kleinfragment-Sortiment

Plates, Small Fragment Portfolio

St

Edelstahl
Stainless steel

1

VE = Verpackungseinheit
SU = Quantity/pack



Nut
Groove

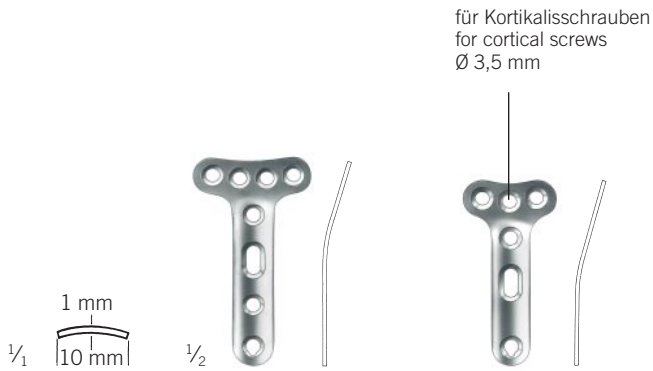

T-Platten, rechtwinklig T-Plates, right-angled

St 1

Länge Length	Löcher Holes	Art.-Nr. Item No.
45 mm	3 x 3	25-141-13-05
58 mm	4 x 4	25-141-14-05
66 mm	3 x 5	25-141-15-05
78 mm	4 x 6	25-141-16-05

Indikation: für Fibula, Mittelhand- und Mittelfußknochen als Abstützplatte
Indication: for fibula, metacarpal and metatarsal bone as supporting plate

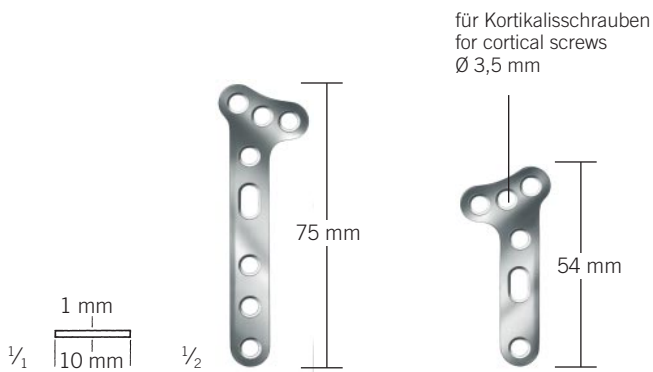

T-Platten, schiefwinklig T-Plates, oblique-angled

St 1

Länge Length	Löcher Holes	Art.-Nr. Item No.
45 mm	3 x 3	25-141-23-05
58 mm	3 x 5	25-141-25-05

Indikation: für Fibula, Mittelhand- und Mittelfußknochen als Abstützplatte
Indication: for fibula, metacarpal and metatarsal bone as supporting plate

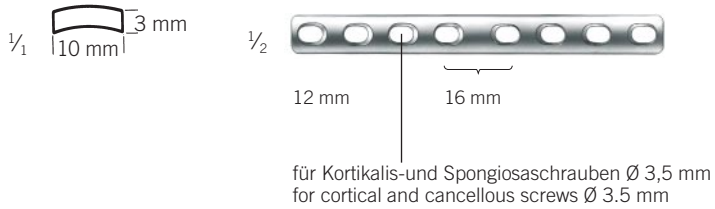

Indikation: Für Fibula, Mittelhand- und Mittelfußknochen als Abstützplatte.
Kompressionswirkung durch exzentrisches, frakturfernes Einsetzen der Schrauben möglich.

Indication: Supporting plate for fibula, metacarpal and metatarsal bone.
Compression through eccentric screw insertion at a distance from the fracture.

Kompressionsplatten
Compression plates

St 1



Mit Nut für Plattenspanner
Notched for plate tensioner

Länge Length	Löcher Holes	Art.-Nr. Item No.
25 mm	2	25-148-02-05
37 mm	3	25-148-03-05
49 mm	4	25-148-04-05
61 mm	5	25-148-05-05
73 mm	6	25-148-06-05
85 mm	7	25-148-07-05
97 mm	8	25-148-08-05
121 mm	10	25-148-10-05
145 mm	12	25-148-12-05

Fz
 Ferrozell



23-433-18-07 Fz
 18 cm / 7 1/8"
 Raspatorium, klein
 Periosteal elevator, small

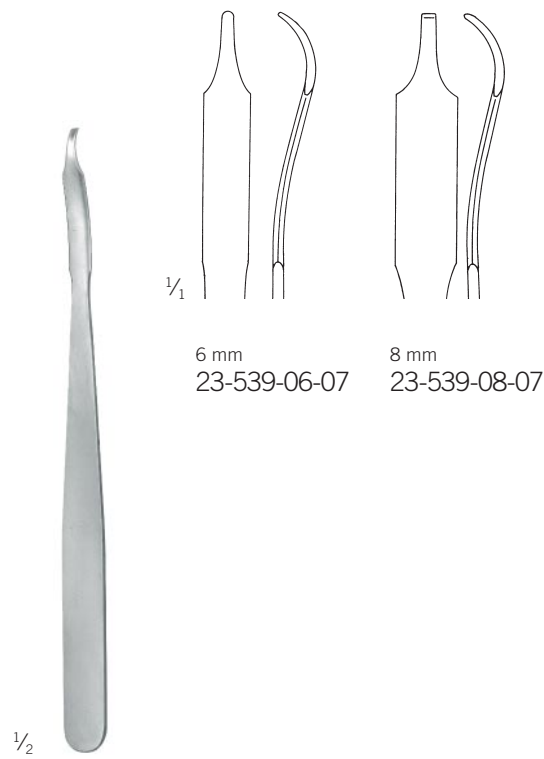

Hohmann, mini
 23-539-06-07 -
 23-539-08-07
 16 cm / 6 2/8"
 Knochenhebel
 Bone lever

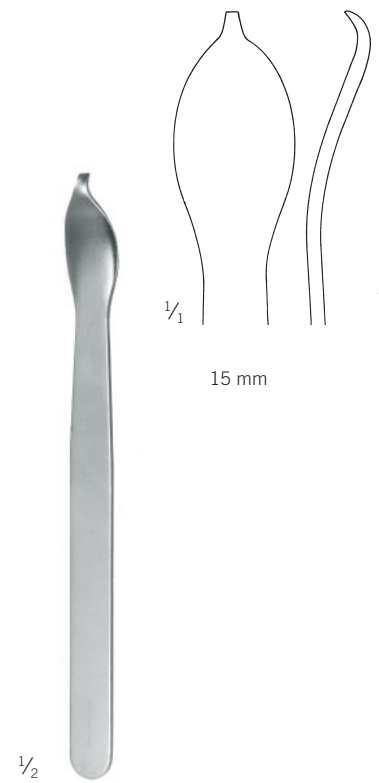

23-539-15-07
 16 cm / 6 2/8"
 Knochenhebel
 Bone lever



1/2

23-704-14-07

14,5 cm / 5 9/16"

Knochenhaltezange, selbstzentrierend
Bone holding forceps, self-centering



1/2

23-721-14-07

15 cm / 5 7/8"

Repositionszange mit Spitzen
Reduction forceps with tips



1/2

23-749-15-07

15 cm / 6"

Repositionszange für kleine Fragmente
Reduction forceps for small fragments

Instrumente, Kleinfragment-Sortiment

Instruments, Small Fragment Portfolio



mit AO-Ansatz
with AO attachment



Ferrozell

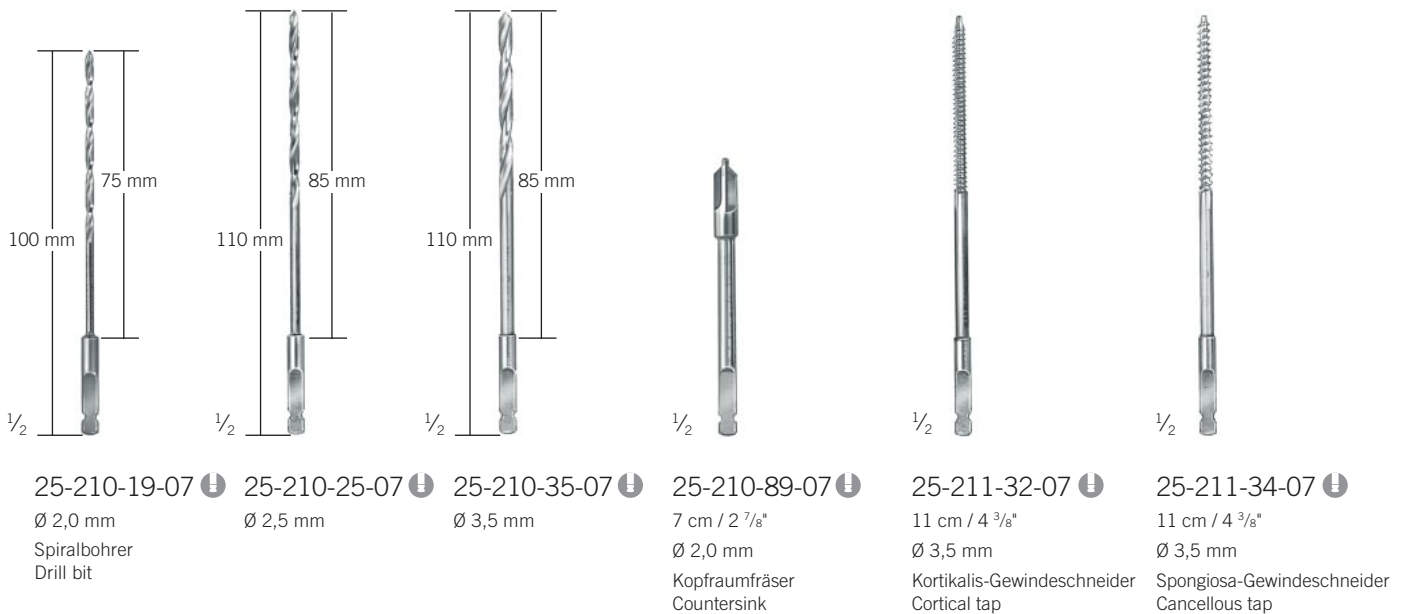

25-210-19-07

Ø 2,0 mm
Spiralbohrer
Drill bit

25-210-25-07

Ø 2,5 mm

25-210-35-07

Ø 3,5 mm

25-210-89-07

7 cm / 2 7/8"
Ø 2,0 mm
Kopfraumfräser
Countersink

25-211-32-07

11 cm / 4 3/8"
Ø 3,5 mm
Kortikalis-Gewindeschneider
Cortical tap

25-211-34-07

11 cm / 4 3/8"
Ø 3,5 mm
Spongiosa-Gewindeschneider
Cancellous tap



für Bohrer Ø 2,0 mm
for drill bit Ø 2.0 mm



25-212-20-01

10 cm / 3 7/8"

Ziel- und Plattenbohrlehre
Drill bit guide and sleeve

für Bohrer Ø 2,5 mm /
Gewindeschneider Ø 3,5 mm

for drill bit Ø 2.5 mm /
tap Ø 3.5 mm

für Kortikalis-Schrauben Ø 3,5 mm
for cortical screws Ø 3.5 mm



25-212-27-01

10,5 cm / 4 1/8"

Gewebeschutzhülse und Bohrlehre
Soft-tissue sleeve and drill bit guide

für Bohrer Ø 2,5 mm / 2,7 mm
für Schrauben Ø 2,7 mm / 3,5 mm

for drill bit Ø 2.5 mm / 2.7 mm
for screws Ø 2.7 mm / 3.5 mm



25-212-44-01

10,5 cm / 4 1/8"

Steckbohrbüchse
Drill bit sleeve



1/2

25-211-43-07 

11 cm / 4 3/8"

Handstück für AO-Ansatz
Handle for AO attachment



mit AO-Ansatz
 with AO attachment



25-214-02-07
 19,5 cm / 7 7/8"
 Schraubendreher
 Screwdriver



25-214-03-07
 10 cm / 3 7/8"
 Schraubendreher-Einsatz
 Screwdriver bit



25-222-32-01
 14 cm / 5 1/8"
 Bohrlehre neutral und exzentrisch
 Drill bit guide, neutral and eccentric



25-219-04-07
 16 cm / 6 3/8"
 Schraubenmessgerät, klein
 Depth gauge, small



1/2

25-219-39-07
15,5 cm / 6"
Scharfer Haken
Sharp hook



1/2

25-219-43-01
Ø 3,5 mm
Halteklammer
Plateholding clip



1/2

25-219-97-07
8 cm / 3 1/8"
Schraubenpinzette
Screw forceps



1/2

25-229-04-07
14,5 cm / 5 7/8"
Schränkeisen für kleine Platten I
Bending iron for small plates I



1/2

25-229-05-07
14,5 cm / 5 7/8"
Schränkeisen für kleine Platten II
Bending iron for small plates II



25-229-15-07
22 cm / 8 7/8"
Biegezange für kleine Platten
Bending pliers for small plates



25-229-55-01
Biegeschablone 5-Loch
Bending templates 5-holes



25-229-57-01
Biegeschablone 7-Loch
Bending templates 7-holes



Kleinfragment-Set

Small Fragment Set

St

Edelstahl
Stainless steel

5

VE = Verpackungseinheit
SU = Quantity/pack



25-120-00-04

Schrauben und Platten, Kleinfragment-Set
Screws and Plates, Small Fragment Set

Kortikalisschraube Cortex screw		
Ø 3,5 mm St 5		
Art.-Nr. Item No.	Länge Length	Stückzahl/Set Quantity/set
25-104-10-05	10 mm	5
25-104-12-05	12 mm	5
25-104-14-05	14 mm	5
25-104-16-05	16 mm	5
25-104-18-05	18 mm	5
25-104-20-05	20 mm	5
25-104-22-05	22 mm	5
25-104-24-05	24 mm	5
25-104-26-05	26 mm	5
25-104-28-05	28 mm	5
25-104-32-05	32 mm	5
25-104-36-05	36 mm	5
25-104-40-05	40 mm	5

Malleolarschraube Malleolar screw		
Ø 3,5 mm St 5		
Art.-Nr. Item No.	Länge Length	Stückzahl/Set Quantity/set
25-106-14-05	14 mm	5
25-106-16-05	16 mm	5
25-106-18-05	18 mm	5
25-106-20-05	20 mm	5
25-106-22-05	22 mm	5
25-106-24-05	24 mm	5
25-106-26-05	26 mm	5
25-106-28-05	28 mm	5
25-106-32-05	32 mm	5
25-106-36-05	36 mm	5
25-106-40-05	40 mm	5
25-106-45-05	45 mm	5
25-106-50-05	50 mm	5
25-106-55-05	55 mm	5
25-106-60-05	60 mm	5

Spongiosaschraube Concellous bone screw		
Ø 4,0 mm St 5		
Art.-Nr. Item No.	Länge Length	Stückzahl/Set Quantity/set
25-107-12-05	12 mm	5
25-107-14-05	14 mm	5
25-107-16-05	16 mm	5
25-107-18-05	18 mm	5
25-107-20-05	20 mm	5
25-107-22-05	22 mm	5
25-107-24-05	24 mm	5
25-107-26-05	26 mm	5
25-107-28-05	28 mm	5
25-107-30-05	30 mm	5
25-107-35-05	35 mm	5
25-107-40-05	40 mm	5
25-107-45-05	45 mm	5
25-107-50-05	50 mm	5



Art.-Nr. Item No.	Länge Length	Lochzahl Holes	Stückzahl/Set Quantity/set
Kleeblatt-Platte Cloverleaf plate			St 1
25-140-23-05	88 mm	3	1
25-140-24-05	105 mm	4	1
Drittelrohrplatte One-third tubular plate			St 1
25-141-02-05	25 mm	2	1
25-141-03-05	37 mm	3	2
25-141-04-05	49 mm	4	2
25-141-05-05	61 mm	5	2
25-141-06-05	73 mm	6	2
25-141-07-05	85 mm	7	1
25-141-08-05	125 mm	12	1

Art.-Nr. Item No.	Länge Length	Lochzahl Holes	Stückzahl/Set Quantity/set
T-Platte, klein, rechtwinklig T-Plate, small, right-angled			St 1
25-141-13-05	45 mm	3 x 3	1
25-141-14-05	58 mm	4 x 4	1
T-Platte, schiefwinklig T-Plate, oblique-angled			St 1
25-141-23-05	54 mm	3 x 3	1
25-141-25-05	75 mm	3 x 5	1
Schmale Kompressionsplatte Small compression plate			St 1
25-148-06-05	73 mm	6	2
25-148-08-05	97 mm	8	2
25-148-10-05	121 mm	10	1

Kleinfragment-Set

Small Fragment Set

St

Edelstahl
Stainless steel

5

VE = Verpackungseinheit
SU = Quantity/pack



25-120-00-04			Instrumente, Kleinfragment-Set, komplett, bestehend aus:	Instruments, Small Fragment Set, complete, consisting of:
Art.-Nr. Item No.	Stückzahl/Set Quantity/set	VE SU	Bezeichnung	Designation
23-539-15-07	1	1	Knochenhebel, 15 mm	Bone lever, 15 mm
23-704-14-07	1	1	Knochenhaltezange mit Ratsche	Bone holding forceps with ratchet
23-721-14-07	1	1	Repositionszange, spitz-spitz	Reduction forceps with tips
23-749-15-07	1	1	Knochenhaltezange mit Rändelschraube	Bone holding forceps with knurled screw
25-210-19-07	2	1	Spiralbohrer Ø 2,0 mm	Drill bit Ø 2.0 mm
25-210-25-07	2	1	Spiralbohrer Ø 2,5 mm	Drill bit Ø 2.5 mm
25-210-35-07	2	1	Spiralbohrer Ø 3,5 mm	Drill bit Ø 3.5 mm
25-210-89-07	1	1	Kopfraumfräser Ø 2,0 mm	Countersink Ø 2.0 mm
25-211-32-07	2	1	Kortikalisgewindeschneider Ø 3,5 mm	Tap for cortical bone Ø 3.5 mm
25-211-34-07	2	1	Spongiosagewindeschneider Ø 3,5 mm	Tap for cancellous bone Ø 3.5 mm
25-211-43-07	1	1	Handstück für AO-Ansatz	Handle with AO attachment
25-212-20-01	1	1	Bohrbüchse Ø 2,0 mm	Drill guide Ø 2.0 mm
25-212-27-01	1	1	Gewebeschutz- u. Bohrbüchse 3,5/2,5 mm	Tap/ Drill bit sleeve, 3.5/2.5 mm
25-212-44-01	1	1	Steckbohrbüchse, 3,5/2,7 mm	Insert drill bit sleeve, 3.5/2.7 mm
25-214-02-07	1	1	Schraubendreher, Inbus, 2,5 mm	Screwdriver, hexagon, 2.5 mm
25-214-03-07	1	1	Schraubendrehereinsatz, Inbus, 2,5 mm	Screwdriver insert, hexagon, 2.5 mm
25-219-04-07	1	1	Schraubenmessgerät, klein, 16 cm	Depth gauge, small, 16 cm
25-219-39-07	1	1	Scharfer Haken	Sharp hook
25-219-43-01	2	1	Halteklammer für Platten Ø 3,5 mm	Plate-holding clip Ø 3.5 mm
25-219-97-07	1	1	Schraubenpinzette, selbsthaltend	Screw forceps, self-retaining
25-222-32-01	1	1	Bohrbüchse für Schrauben mit Ø 3,5 mm	Drill guide for Ø 3.5-mm screws
25-229-04-07	1	1	Schränkeisen für kleine Platten I	Bending iron for small plates I
25-229-05-07	1	1	Schränkeisen für kleine Platten II	Bending iron for small plates II
25-229-15-07	1	1	Biegezange, mittlere Größe	Bending pliers, mid-size
25-229-55-01	1	1	Biegeschablone, 5-Loch, 6 cm	Bending template, small, 5-hole, 6 cm
25-229-57-01	1	1	Biegeschablone, 7-Loch, 8,5 cm	Bending template, small, 7-hole, 8.5 cm
25-119-98-05	6	1	Unterlegscheibe, Ø 7 mm	Washer, Ø 7 mm



55-440-15-04
300 x 300 x 160 mm
MicroStop®-Container
MicroStop® container

Lagerung Storage				
Art.-Nr. Item No.	Stückzahl/Set Quantity/set	VE SU	Bezeichnung	Designation
55-440-15-04	1	①	MicroStop®-Container 300 x 300 x 160 mm	MicroStop® container 300 x 300 x 160 mm
55-443-12-04	2	①	Farbreiter, rot	Color tag, red
55-443-22-04	2	①	Codierschild mit Beschriftung, ohne Loch	Coding label, lettered, no hole
55-805-25-01	1	①	Siebkorb 1/2, 243 x 255 x 53 mm	Sterilization tray 1/2, 243 x 255 x 53 mm
55-806-02-04	1	⑩	Clip, allein für Fixierelement	Clip, only for fixation element
55-806-51-04	4	①	Trennwand, Siebkorb, 123 x 9 x 40 mm	Partition wall, tray, 123 x 9 x 40 mm
55-996-55-04	1	①	Abdecktuch, OP-Grün, 1000 x 1000 mm	Covering towel, OR-green, 1000 x 1000 mm
56-535-00-04	1	①	Lagerungsrack Kleinfragment, leer	Small fragment rack, empty



Minifragment-System
Mini Fragment System

45-61

Schrauben und Platten, Minifragment-Sortiment

Screws and Plates, Mini Fragment Portfolio

St

Edelstahl
Stainless steel

Ti

Titan
Titanium

5

VE = Verpackungseinheit
SU = Quantity/pack

Kortikalisschraube Cortex screw

Ø 1,5 mm

St **5**

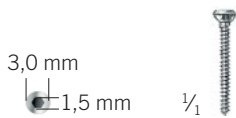

Länge Length	standard standard
6 mm	25-110-06-05
7 mm	25-110-07-05
8 mm	25-110-08-05
9 mm	25-110-09-05
10 mm	25-110-10-05
11 mm	25-110-11-05
12 mm	25-110-12-05
14 mm	25-110-14-05
16 mm	25-110-16-05
18 mm	25-110-18-05
20 mm	25-110-20-05

Kortikalisschraube Cortex screw

Ø 2,0 mm

St **5**

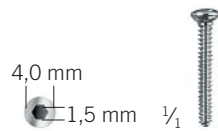

Länge Length	standard standard
6 mm	25-111-06-05
8 mm	25-111-08-05
10 mm	25-111-10-05
12 mm	25-111-12-05
14 mm	25-111-14-05
16 mm	25-111-16-05
18 mm	25-111-18-05
20 mm	25-111-20-05
22 mm	25-111-22-05
24 mm	25-111-24-05
26 mm	25-111-26-05
28 mm	25-111-28-05
30 mm	25-111-30-05
32 mm	25-111-32-05
34 mm	25-111-34-05
36 mm	25-111-36-05
38 mm	25-111-38-05

Kortikalisschraube Cortex screw

Ø 2,7 mm

St **5**



Länge Length	selbstschneidend self-tapping	standard standard
6 mm		25-102-06-05
8 mm	25-101-08-05	25-102-08-05
10 mm	25-101-10-05	25-102-10-05
12 mm	25-101-12-05	25-102-12-05
14 mm	25-101-14-05	25-102-14-05
16 mm	25-101-16-05	25-102-16-05
18 mm	25-101-18-05	25-102-18-05
20 mm	25-101-20-05	25-102-20-05
22 mm	25-101-22-05	25-102-22-05
24 mm	25-101-24-05	25-102-24-05
26 mm	25-101-26-05	25-102-26-05
28 mm	25-101-28-05	25-102-28-05
30 mm	25-101-30-05	25-102-30-05
32 mm	25-101-32-05	25-102-32-05
34 mm	25-101-34-05	25-102-34-05
36 mm		25-102-36-05
38 mm		25-102-38-05
40 mm		25-102-40-05

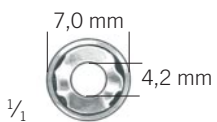

25-119-98-05

Unterlegscheibe
Washer



56-535-00-04

Lagerungsrack Minifragment, leer
Small fragment rack, empty

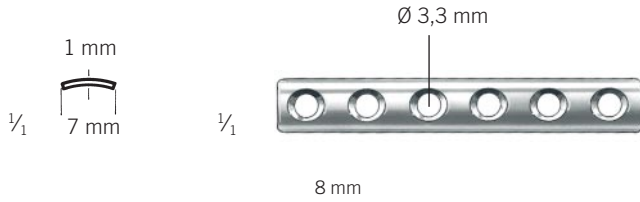

Viertelrohrplatten
Quarter-tubular plates

St 1



Mit Nut für Plattenspanner
Notched for plate tensioner

Indikation: Für Fibula, Mittelhand- und Mittelfußknochen als Abstützplatte.
Kompressionswirkung durch exzentrisches, frakturfernes Einsetzen der Schrauben möglich.

Indication: Supporting plate for fibula, metacarpal and metatarsal bone.
Compression through eccentric screw insertion at a distance from the fracture.

Länge Length	Löcher Holes	Art.-Nr. Item No.
23 mm	3	25-142-13-05
31 mm	4	25-142-14-05
39 mm	5	25-142-15-05
47 mm	6	25-142-16-05
55 mm	7	25-142-17-05
63 mm	8	25-142-18-05
71 mm	9	25-142-19-05

Mehrfragmentplatten
Multi fragment plates



25-142-21-05

Indikation: Für Fibula, Mittelhand- und Mittelfußknochen als Abstützplatte
Indication: For fibula, metacarpal and metatarsal bone as supporting plate

Mehrfragmentplatten
Multi fragment plates



25-142-31-05
32 mm

25-142-32-05
32 mm

25-142-33-05
35 mm

25-142-34-05
35 mm

25-142-41-05
32 mm

links
left

rechts
right

schräg, links
oblique, left

schräg, rechts
oblique, right

Kompressionswirkung durch exzentrisches, frakturfernes Einsetzen der Schrauben möglich.
Compression through eccentric, fracture distant use of the screws.

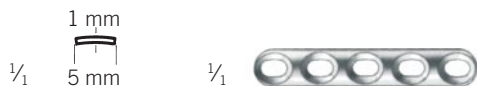

Mini-Platten
Mini plates

St 1

Indikation: Für Fibula, Mittelhand- und Mittelfußknochen als Abstützplatte
Indication: For fibula, metacarpal and metatarsal bone as supporting plate

Länge Length	Löcher Holes	Art.-Nr. Item No.
17 mm	3	25-143-13-05
23 mm	4	25-143-14-05
29 mm	5	25-143-15-05
35 mm	6	25-143-16-05



Mini-Platten
Mini plates

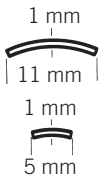

25-143-33-05
20 mm
schräg, links
oblique, left



25-143-34-05
20 mm
schräg, rechts
oblique, right



25-143-31-05
19 mm
links
left



25-143-32-05
19 mm
rechts
right



25-143-41-05
18 mm

1/1



8 mm 12 mm

2,0 mm = 25-144-02-05 - 25-144-06-05
8 mm

2,5 mm = 25-144-07-05 - 25-144-12-05
8 mm

Indikation: Für Fibula, Mittelhand- und Mittelfußknochen als Abstützplatte.
Kompressionswirkung durch exzentrisches, frakturfernes Einsetzen der Schrauben möglich.

Indication: Supporting plate for fibula, metacarpal and metatarsal bone.
Compression through eccentric screw insertion at a distance from the fracture.

Schmale Kompressionsplatten
Small compression plates

St 1

Länge Length	Löcher Holes	Art.-Nr. Item No.
20 mm	2	25-144-02-05
36 mm	4	25-144-04-05
44 mm	5	25-144-05-05
52 mm	6	25-144-06-05
60 mm	7	25-144-07-05
68 mm	8	25-144-08-05
76 mm	9	25-144-09-05
84 mm	10	25-144-10-05
100 mm	12	25-144-12-05

Fz
Ferrozell



23-435-18-07 
18 cm / 7 1/8"
Raspatorium, klein
Periosteal elevator, small

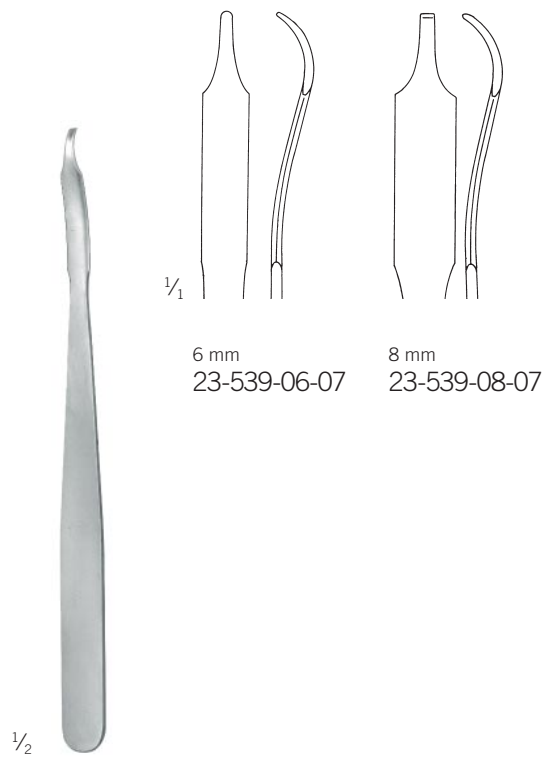

Hohmann, mini
23-539-06-07 -
23-539-08-07
16 cm / 6 2/8"
Knochenhebel
Bone lever

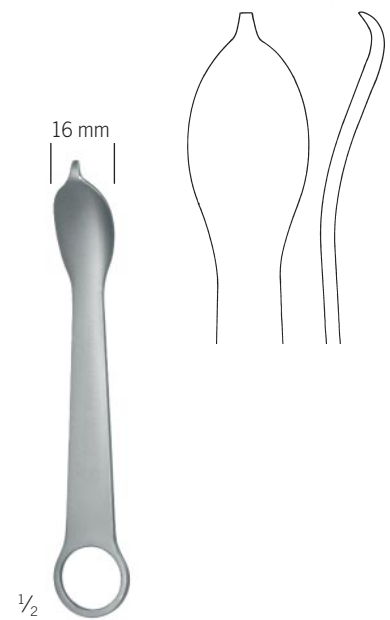

23-539-16-07
16 cm / 6 2/8"
Knochenhebel
Bone lever



$\frac{1}{2}$

23-704-14-07

14,5 cm / 5 $\frac{7}{8}$ "

Knochenhaltezange, selbstzentrierend
Bone holding forceps, self-centering



$\frac{1}{2}$

23-717-12-07

12 cm / 4 $\frac{7}{8}$ "

Haltezange für Mini-Platten
Mini-plate holding forceps



$\frac{1}{2}$

23-721-14-07

15 cm / 5 $\frac{7}{8}$ "

Repositionszange mit Spitzen
Reduction forceps with tips

Instrumente, Minifragment-Sortiment

Instruments, Mini Fragment Portfolio



mit AO-Ansatz
with AO attachment



Ferrozell

für Schrauben \varnothing 2,7 / 3,5 / 4,0 mm
for screws \varnothing 2.7 / 3.5 / 4.0 mm

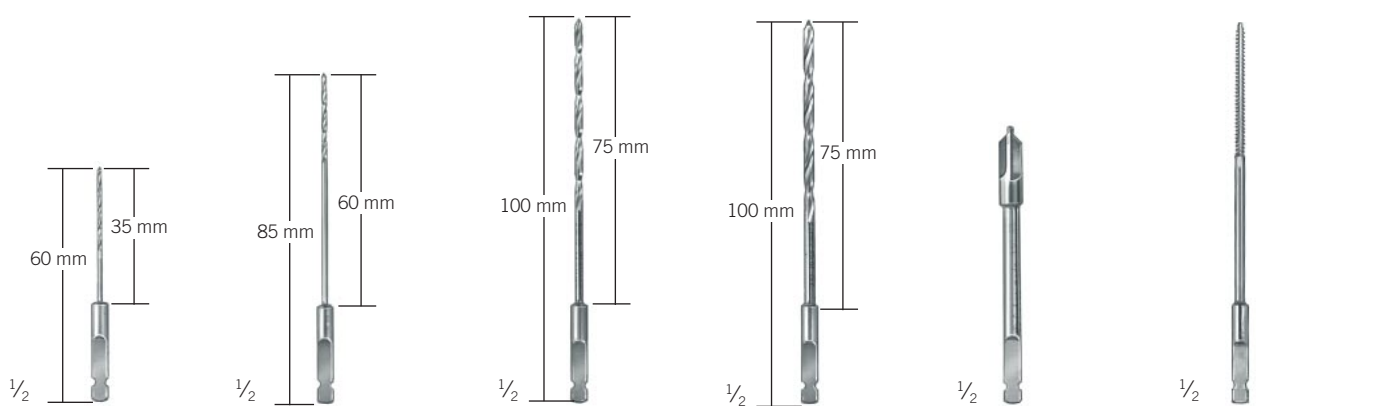

25-210-11-07

\varnothing 1,1 mm

Spiralbohrer
Drill bit

25-210-15-07

\varnothing 1,5 mm

25-210-19-07

\varnothing 2,0 mm

Spiralbohrer
Drill bits

25-210-26-07

\varnothing 2,7 mm

25-210-89-07

7 cm / 2 7/8"

\varnothing 2,0 mm
Kopfraumfräser
Countersink

25-211-26-07

10 cm / 3 7/8"

\varnothing 2,7 mm
Gewindeschneider
Tap



mit Dental-Ansatz
with Dental attachment



1/2

25-211-43-07 
11 cm / 4 3/8"
Handstück für AO-Ansatz
Handle for AO attachment



1/2

25-214-03-07 
10 cm / 3 7/8"
Ø 2,5 mm
Schraubendreher-Einsatz
Screwdriver bit

für Schrauben Ø1,5 / 2,0 mm
for screws Ø1.5 / 2.0 mm



1/2

25-210-88-07 
5,5 cm / 2 2/8"
Ø 1,1 mm
Mini-Kopfraumfräser
Mini-countersink



1/2

25-211-15-07 
5 cm / 2"
Ø 1,5 mm
Gewindeschneider
Tap



1/2

25-211-19-07 
5,5 cm / 2 2/8"
Ø 2,0 mm



1/2

25-210-95-07 
10,5 cm / 4 1/8"
Handstück für
Dental-Ansatz
Handle for dental
attachment



1/2

25-214-32-07 
5,5 cm / 2 2/8"
Ø 1,5 mm
Schraubendreher-Einsatz
Screwdriver bit



25-212-15-01
 10,5 cm / 4 1/8"
 Mini-Bohrlehre für Bohrer
 Ø 1,1/1,5 mm
 Mini drill bit sleeve for drill bit
 Ø 1.1/1.5 mm

für Bohrer Ø 2,0 mm
 for drill bit Ø 2.0 mm



25-212-20-01
 10 cm / 3 7/8"
 Ziel- und Plattenbohrlehre
 Drill bit guide and sleeve



für Bohrer Ø 3,5 mm
 for drill bit Ø 3.5 mm

25-212-26-01
 11 cm / 4 1/2"
 Geweschutzhülse
 Soft-tissue sleeve



25-219-03-07
 11 cm / 4 3/8"
 Mini-Schraubenmessgerät
 Mini depth gauge



25-219-04-07
16 cm / 6 3/8"
Schraubenmessgerät, klein
Depth gauge, small



25-219-39-07
15,5 cm / 6 1/8"
Scharfer Haken
Sharp hook



25-219-41-01
Halteklammer
Clip for plateholding



25-219-42-01



25-219-97-07
8 cm / 3 1/8"
Schraubenpinzette
Screw forceps

für Bohrer Ø 2,0 mm
für Kortikalisschrauben Ø 2,7 mm

for drill bit Ø 2.0 mm
for cortical screws Ø 2.7 mm

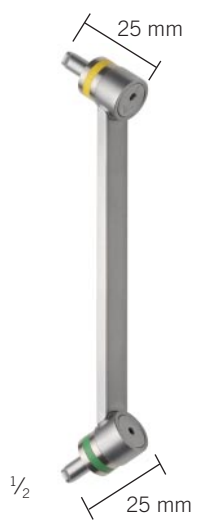

25-222-21-01
12 cm / 4 7/8"
Bohrlehre
Drill bit guide,
neutral and eccentric



25-229-01-07
13 cm / 5"
2,0 mm
Schränkeisen
Bending iron



25-229-10-07
13,5 cm / 5 3/8"
2,7 mm
Biegezange
Bending pliers



25-229-15-07
22 cm / 8 7/8"
Biegezange für kleine Platten
Bending pliers for small plates

für kleine Platten
bis Profilhöhe 3 mm
for small plates,
max. profile height 3 mm

25-229-90-98

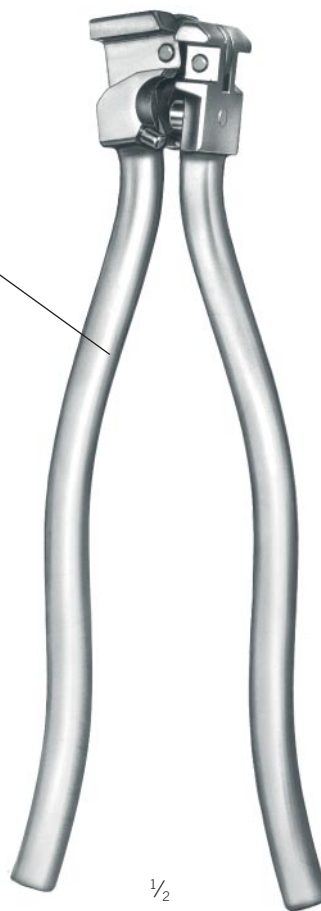

25-229-29-07
24 cm / 9 1/2"
Biegezange für Rekonstruktionsplatten
Bending pliers for reconstruction plates



25-298-99-07
12 cm / 4 7/8"
Haltezange für Mini-Platten
Mini-plate holding forceps

Minifragment-Set

Mini Fragment Set

St

Edelstahl
Stainless steel

5

VE = Verpackungseinheit
SU = Quantity/pack



25-110-00-04

Schrauben und Platten, Minifragment-Set
Screws and Plates, Mini Fragment Set

Kortikalisschraube Cortex screw			Ø 1,5 mm	St	5
Art.-Nr. Item No.	Länge Length	Stückzahl/Set Quantity/set			
25-110-06-05	6 mm	5			
25-110-07-05	7 mm	5			
25-110-08-05	8 mm	5			
25-110-09-05	9 mm	5			
25-110-10-05	10 mm	5			
25-110-12-05	12 mm	5			
25-110-14-05	14 mm	5			
25-110-16-05	16 mm	5			

Kortikalisschraube Cortex screw			Ø 2,0 mm	St	5
Art.-Nr. Item No.	Länge Length	Stückzahl/Set Quantity/set			
25-111-06-05	6 mm	5			
25-111-08-05	8 mm	5			
25-111-10-05	10 mm	5			
25-111-12-05	12 mm	5			
25-111-14-05	14 mm	5			
25-111-16-05	16 mm	5			
25-111-18-05	18 mm	5			
25-111-20-05	20 mm	5			

Kortikalisschraube Cortex screw			Ø 2,7 mm	St	5
Art.-Nr. Item No.	Länge Length	Stückzahl/Set Quantity/set			
25-102-08-05	8 mm	5			
25-102-10-05	10 mm	5			
25-102-12-05	12 mm	5			
25-102-14-05	14 mm	5			
25-102-16-05	16 mm	5			
25-102-18-05	18 mm	5			
25-102-20-05	20 mm	5			
25-102-22-05	22 mm	5			
25-102-24-05	24 mm	5			



Art.-Nr. Item No.	Länge Length	Lochzahl Holes	Stückzahl/Set Quantity/set
Viertelrohrplatte Quarter-tubular plate			St 1
25-142-13-05	23 mm	3	2
25-142-14-05	31 mm	4	2
25-142-15-05	39 mm	5	2
25-142-16-05	47 mm	6	1
25-142-17-05	55 mm	7	1
25-142-18-05	63 mm	8	1
L-Platte, schiefwinklig L-plate, oblique-angled			St 1
25-142-33-05	35 mm	links/left	2
25-142-34-05	35 mm	rechts/right	2

Art.-Nr. Item No.	Länge Length	Lochzahl Holes	Stückzahl/Set Quantity/set
Mini-Platte, gerade Mini-plate, straight			St 1
25-143-13-05	17 mm	3	2
25-143-14-05	23 mm	4	2
25-143-15-05	29 mm	5	2
L-Platte, schiefwinklig L-plate, oblique-angled			St 1
25-143-33-05	20 mm	links/left	2
25-143-34-05	20 mm	rechts/right	2
T-Platte T-plate			St 1
25-143-41-05	18 mm	4	4

Minifragment-Set

Mini Fragment Set

St

Edelstahl
Stainless steel

5

VE = Verpackungseinheit
SU = Quantity/pack



25-110-00-04			Instrumente, Minifragment-Set, komplett, bestehend aus:	Instruments, Mini Fragment Set, complete, consisting of:
Art.-Nr. Item No.	Stückzahl/Set Quantity/set	VE SU	Bezeichnung	Designation
22-622-06-05	1	10	Kirschnerdraht, 0,6 x 60 mm	K-wire, 0.6 x 60 mm
22-622-08-05	1	10	Kirschnerdraht, 0,8 x 60 mm	K-wire, 0.8 x 60 mm
22-630-10-05	1	10	Kirschnerdraht, 1,0 x 160 mm	K-wire, 1.0 x 160 mm
22-630-12-05	1	10	Kirschnerdraht, 1,2 x 160 mm	K-wire, 1.2 x 160 mm
22-630-16-05	1	10	Kirschnerdraht, 1,6 x 160 mm	K-wire, 1.6 x 160 mm
23-433-03-07	1	1	Raspatorium, 3 mm	Raspatory, 3 mm
23-539-06-07	1	1	Knochenheber, Hohmann mini, 6 mm	Bone lever, Mini-Hohmann, 6 mm
23-539-08-07	1	1	Knochenheber, Hohmann mini, 8 mm	Bone lever, Mini-Hohmann, 8 mm
23-539-16-07	1	1	Knochenheber, 16 mm	Bone lever, 16 mm
23-704-14-07	1	1	Knochenhaltezange mit Ratsche	Bone holding forceps with ratchet
23-717-12-07	1	1	Repositionszange für Miniplatten	Reduction forceps for mini-plates
23-721-14-07	1	1	Repositionszange, spitz-spitz	Reduction forceps with tips
25-210-11-07	2	1	Spiralbohrer Ø 1,1 mm	Drill bit Ø 1.1 mm
25-210-15-07	2	1	Spiralbohrer Ø 1,5 mm	Drill bit Ø 1.5 mm
25-210-19-07	2	1	Spiralbohrer Ø 2,0 mm	Drill bit Ø 2.0 mm
25-210-26-07	2	1	Spiralbohrer Ø 2,7 mm	Drill bit Ø 2.7 mm
25-210-88-07	1	1	Kopfraumfräser Ø 1,1 mm	Countersink, Ø 1.1 mm
25-210-89-07	1	1	Kopfraumfräser Ø 2,0 mm	Countersink, Ø 2.0 mm
25-210-95-07	1	1	Handstück für Dental-Ansatz	Handle with dental attachment
25-211-15-07	2	1	Gewindeschneider Ø 1,5 mm	Tap Ø 1.5 mm
25-211-19-07	2	1	Gewindeschneider Ø 2,0 mm	Tap Ø 2.0 mm
25-211-26-07	2	1	Gewindeschneider Ø 2,7 mm	Tap Ø 2.7 mm
25-211-43-07	1	1	Handstück für AO-Ansatz	Handle with AO attachment
25-212-15-01	1	1	Bohrbüchse Ø 1,1/1,5 mm	Drill guide Ø 1.1/1.5 mm
25-212-20-01	1	1	Bohrbüchse Ø 2,0 mm	Drill guide Ø 2.0 mm
25-212-26-01	1	1	Gewebeschutzhülse Ø 3,5 mm	Tap sleeve Ø 3.5 mm
25-214-03-07	1	1	Schraubendrehereinsatz, Inbus 2,5 mm	Screwdriver insert, hexagon, 2.5 mm
25-214-32-07	1	1	Schraubendrehereinsatz, Inbus 1,5 mm	Screwdriver insert, hexagon, 1.5 mm



55-440-15-04
300 x 300 x 160 mm
MicroStop®-Container
MicroStop® container

25-110-00-04			Instrumente, Minifragment-Set, komplett, bestehend aus:	Instruments, Mini Fragment Set, complete, consisting of:
Art.-Nr. Item No.	Stückzahl/Set Quantity/set	VE SU	Bezeichnung	Designation
25-219-03-07	1	①	Schraubenmessgerät, mini, 11 cm	Depth gauge mini, 11 cm
25-219-04-07	1	①	Schraubenmessgerät, klein, 16 cm	Depth gauge small, 16 cm
25-219-39-07	1	①	Scharfer Haken	Sharp hook
25-219-41-01	2	①	Halteklammer für Platten, 2,0 mm	Plate holding clip 2.0 mm
25-219-42-01	3	①	Halteklammer für Platten, 2,7 mm	Plate holding clip 2.7 mm
25-219-97-07	1	①	Schraubenpinzette, selbsthaltend	Screw forceps, self-retaining
25-222-21-01	1	①	Bohrbüchse für Schrauben mit Ø 2,7 mm	Drill guide for Ø 2,7-mm screws
25-229-01-07	2	①	Schränkeisen	Bending iron
25-229-10-07	1	①	Biegezange klein	Bending pliers small
25-229-15-07	1	①	Biegezange mittel	Bending pliers mid-size
25-229-29-07	1	①	Biegezange für Rekonstruktionsplatten	Bending pliers for reconstruction plates
25-298-99-07	1	①	Haltezange für kleine Platten	Holding forceps for small plates
55-337-02-01	1	①	Nadelbox, gelocht 150 X 95 X 13 mm	Needle case, perforated 150 x 95 x 13 mm

25-110-00-04			Lagerung	Storage
Art.-Nr. Item No.	Stückzahl/Set Quantity/set	VE SU	Bezeichnung	Designation
55-440-15-04	1	①	MicroStop®-Container 300 x 300 x 160 mm	MicroStop® container 300 x 300 x 160 mm
55-443-12-04	2	①	Farbreiter, rot	Color tag, red
55-443-22-04	2	①	Codierschild mit Beschriftung, ohne Loch	Coding label, lettered, no hole
55-805-25-01	1	①	Siebkorb 1/2, 243 x 255 x 53 mm	Sterilization tray 1/2, 243 x 255 x 53 mm
55-806-02-04	1	⑩	Clip, allein für Fixierelement	Clip, only for fixation element
55-806-51-04	4	①	Trennwand, Siebkorb, 123 x 9 x 40 mm	Partition wall, tray, 123 x 9 x 40 mm
55-996-55-04	1	①	Abdecktuch, OP-Grün, 1000 x 1000 mm	Covering towel, OR-green, 1000 x 1000 mm
56-540-00-04	1	①	Lagerungsrack, Minifragmentsystem	Rack, mini fragment system



Hohlschrauben-System
Cannulated Screw System

63-69

Hohlschrauben-Sortiment

Cannulated Screw Portfolio

St

Edelstahl
Stainless steel

5

VE = Verpackungseinheit
SU = Quantity/pack

Navicular-Hohlschrauben Navicular cannulated screws

Ø 4,0 mm

St 5

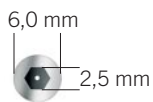

Länge Length	Gewindelänge Length of thread	selbstschneidend self-tapping
10 mm	4 mm	25-607-10-05
12 mm	4 mm	25-607-12-05
14 mm	4 mm	25-607-14-05
16 mm	5 mm	25-607-16-05
18 mm	6 mm	25-607-18-05
20 mm	7 mm	25-607-20-05
22 mm	8 mm	25-607-22-05
24 mm	9 mm	25-607-24-05
26 mm	10 mm	25-607-26-05
28 mm	10 mm	25-607-28-05
30 mm	10 mm	25-607-30-05

Malleolar-Hohlschrauben Malleolar cannulated screws

Ø 4,5 mm

St 5

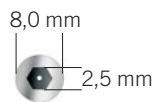

Länge Length	Gewindelänge Length of thread	selbstschneidend self-tapping
25 mm	12 mm	25-615-25-05
30 mm	15 mm	25-615-30-05
35 mm	18 mm	25-615-35-05
40 mm	20 mm	25-615-40-05
45 mm	22 mm	25-615-45-05
50 mm	24 mm	25-615-50-05
55 mm	26 mm	25-615-55-05



1/1

25-119-98-05

Unterlegscheibe
Washer

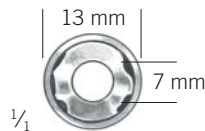



1/1

25-119-99-05

Unterlegscheibe
Washer

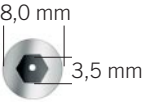

Hohlschrauben Cannulated screws		Gewindelänge Length of thread	Gewindelänge Length of thread
Ø 7,0 mm  		16 mm 	32 mm 
Länge Length	Art.-Nr. Item No.	Art.-Nr. Item No.	Art.-Nr. Item No.
25 mm	25-616-25-05		
30 mm	25-616-30-05		
35 mm	25-616-35-05	25-617-35-05	
40 mm	25-616-40-05	25-617-40-05	
45 mm	25-616-45-05	25-617-45-05	
50 mm	25-616-50-05	25-617-50-05	
55 mm	25-616-55-05	25-617-55-05	
60 mm	25-616-60-05	25-617-60-05	
65 mm	25-616-65-05	25-617-65-05	
70 mm	25-616-70-05	25-617-70-05	
75 mm	25-616-75-05	25-617-75-05	
80 mm	25-616-80-05	25-617-80-05	
85 mm	25-616-85-05	25-617-85-05	
90 mm	25-616-90-05	25-617-90-05	
95 mm	25-616-95-05	25-617-95-05	
100 mm	25-616-00-05	25-617-00-05	
105 mm	25-616-05-05	25-617-05-05	
110 mm	25-616-10-05	25-617-10-05	
115 mm	25-616-15-05	25-617-15-05	
120 mm	25-616-20-05	25-617-20-05	

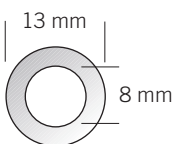

25-620-13-05
Unterlegscheibe
Washer

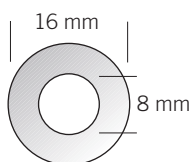

25-620-16-05
Unterlegscheibe
Washer

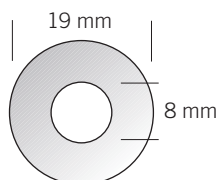

25-620-19-05
Unterlegscheibe
Washer



$\frac{1}{2}$ Ø 1,6 mm
 25-622-10-05 = 100 mm
 25-622-15-05 = 150 mm
 25-622-20-05 = 200 mm
 Führungsspieße für Hohlschrauben Ø 7,0 mm
 Guide wires for cannulated screws Ø 7.0 mm



$\frac{1}{2}$ Ø 1,0 mm
 25-624-10-05 = 100 mm
 25-624-15-05 = 150 mm
 Führungsspieße für Malleolar- und
 Navicular-Hohlschrauben
 Guide wires for malleolar and
 navicular cannulated screws



$\frac{1}{2}$
 25-626-00-07 = Ø 7,0 mm
 25-628-00-07 = Ø 4,5 mm
 Kortikalisfräser
 Cortical reamer



$\frac{1}{2}$
 25-626-05-07 = Ø 7,0 mm
 Vorbohrer für Hohlschrauben
 Drill bit for cannulated screws



1/2



25-626-10-07 = \varnothing 7,0 mm
25-628-03-07 = \varnothing 4,5 mm
Gewindeschneider
Tap

1/2



25-626-15-07 = \varnothing 7,0 mm
25-628-10-07 = \varnothing 4,5 mm
25-630-05-07 = \varnothing 4,0 mm
Eindreh Schlüssel
Hexagonal key

1/2



25-626-20-07
Gewebeschutzhülse
Soft-tissue sleeve

Hohlschrauben-Set

Cannulated Screw Set

St

Edelstahl
Stainless steel

5

VE = Verpackungseinheit
SU = Quantity/pack

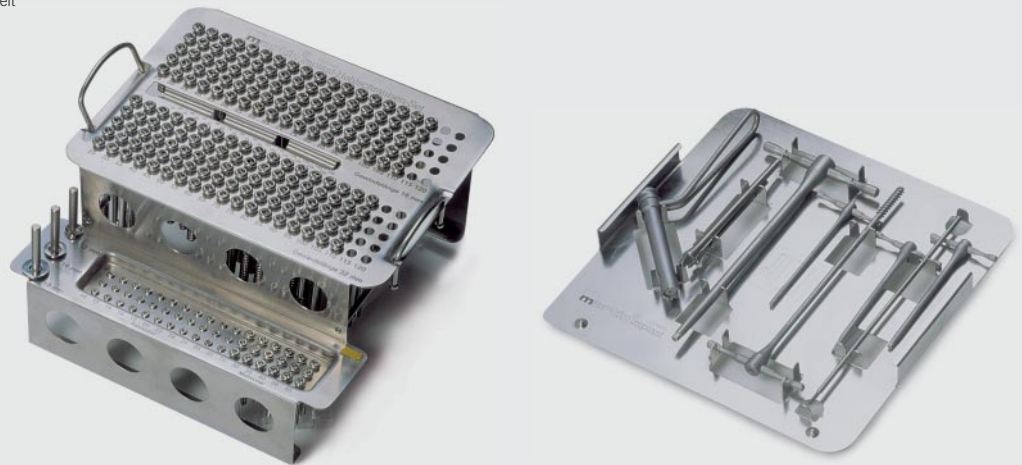

25-600-00-04
Hohlschrauben-Set
Cannulated Screw Set

Navicular-Hohlschrauben Navicular cannulated screws		Ø 4,0 mm	St	5
Art.-Nr. Item No.	Länge Length	Stückzahl/Set Quantity/set		
25-607-10-05	10 mm	5		
25-607-12-05	12 mm	5		
25-607-14-05	14 mm	5		
25-607-16-05	16 mm	5		
25-607-18-05	18 mm	5		
25-607-20-05	20 mm	5		
25-607-22-05	22 mm	5		
25-607-24-05	24 mm	5		
25-607-26-05	26 mm	5		
25-607-28-05	28 mm	5		
25-607-30-05	30 mm	5		

Malleolar-Hohlschrauben Malleolar cannulated screws		Ø 4,5 mm	St	5
Art.-Nr. Item No.	Länge Length	Stückzahl/Set Quantity/set		
25-615-25-05	25 mm	5		
25-615-30-05	30 mm	5		
25-615-35-05	35 mm	5		
25-615-40-05	40 mm	5		
25-615-45-05	45 mm	5		
25-615-50-05	50 mm	5		
25-615-55-05	55 mm	5		

Hohlschrauben Cannulated screws		Ø 7,0 mm	St	5
Art.-Nr. Item No.	Länge Length	Stückzahl/Set Quantity/set		
Gewindelänge / Length of thread 16 mm				
25-616-00-05	100 mm	5		
25-616-05-05	105 mm	5		
25-616-10-05	110 mm	5		
25-616-15-05	115 mm	5		
25-616-20-05	120 mm	5		
25-616-25-05	25 mm	5		
25-616-30-05	30 mm	5		
25-616-35-05	35 mm	5		
25-616-40-05	40 mm	5		
25-616-45-05	45 mm	5		
25-616-50-05	50 mm	5		
25-616-55-05	55 mm	5		
25-616-60-05	60 mm	5		
25-616-65-05	65 mm	5		
25-616-70-05	70 mm	5		
25-616-75-05	75 mm	5		
25-616-80-05	80 mm	5		
25-616-85-05	85 mm	5		
25-616-90-05	90 mm	5		
25-616-95-05	95 mm	5		

Hohlschrauben Cannulated screws		Ø 7,0 mm	St	5
Art.-Nr. Item No.	Länge Length	Stückzahl/Set Quantity/set		
Gewindelänge / Length of thread 32 mm				
25-617-00-05	100 mm	5		
25-617-05-05	105 mm	5		
25-617-10-05	110 mm	5		
25-617-15-05	115 mm	5		
25-617-20-05	120 mm	5		
25-617-35-05	35 mm	5		
25-617-40-05	40 mm	5		
25-617-45-05	45 mm	5		
25-617-50-05	50 mm	5		
25-617-55-05	55 mm	5		
25-617-60-05	60 mm	5		
25-617-65-05	65 mm	5		
25-617-70-05	70 mm	5		
25-617-75-05	75 mm	5		
25-617-80-05	80 mm	5		
25-617-85-05	85 mm	5		
25-617-90-05	90 mm	5		
25-617-95-05	95 mm	5		



55-440-20-04
300 x 300 x 210 mm
MicroStop®-Container
MicroStop® container

25-600-00-04			Instrumente, Hohlschrauben-Set, komplett, bestehend aus:	Instruments, Cannulated Screw Set, complete, consisting of:
Art.-Nr. Item No.	Stückzahl/Set Quantity/set	VE SU	Bezeichnung	Designation
25-620-13-05	6	①	Unterlegscheibe Ø 13 mm	Washer Ø 13 mm
25-620-16-05	6	①	Unterlegscheibe Ø 16 mm	Washer Ø 16 mm
25-620-19-05	6	①	Unterlegscheibe Ø 19 mm	Washer Ø 19 mm
25-622-10-05	1	①	Führungsspieß Ø 1,6 X 100 mm	Guide pin Ø 1.6 X 100 mm
25-622-15-05	1	①	Führungsspieß Ø 1,6 X 150 mm	Guide pin Ø 1.6 X 150 mm
25-622-20-05	1	①	Führungsspieß Ø 1,6 X 200 mm	Guide pin Ø 1.6 X 200 mm
25-624-10-05	1	①	Führungsspieß Ø 1,0 X 100 mm	Guide pin Ø 1.0 X 100 mm
25-624-15-05	1	①	Führungsspieß Ø 1,0 X 150 mm	Guide pin Ø 1.0 X 150 mm
25-626-00-07	1	①	Kortikalisfräser, kanüliert Ø 7,0 mm	Cortex reamer, cannulated Ø 7.0 mm
25-626-05-07	1	①	Vorbohrer, kanüliert Ø 5 mm	Drill bit, cannulated Ø 5 mm
25-626-10-07	1	①	Gewindeschneider, kanüliert Ø 7,0 mm	Tap, cannulated Ø 7 mm
25-626-15-07	1	①	T-Eindrehschlüssel, kanüliert Ø 7,0 mm	T-handle Hexagon, cannulated Ø 7.0 mm
25-626-20-07	1	①	Gewebeschutzhülse	Tissue protection sleeve
25-628-00-07	1	①	Kortikalisfräser, kanüliert Ø 4,5 mm	Cortex reamer, cannulated Ø 4.5 mm
25-628-03-07	1	①	Gewindeschneider, kanüliert, Ø 4,5 mm	Tap, cannulated Ø 4.5 mm
25-628-10-07	1	①	T-Eindrehschlüssel, kanüliert Ø 4,5 mm	T-handle Hexagon, cannulated Ø 4.5 mm
25-630-05-07	1	①	T-Eindrehschlüssel, kanüliert Ø 4,0 mm	T-handle Hexagon, cannulated Ø 4.0 mm

25-600-00-04			Lagerung	Storage
Art.-Nr. Item No.	Stückzahl/Set Quantity/set	VE SU	Bezeichnung	Designation
55-440-20-04	1	①	MicroStop®-Container 300 x 300 x 210 mm	MicroStop® container 300 x 300 x 210 mm
55-443-12-04	2	①	Farbreiter, rot	Color tag, red
55-443-22-04	2	①	Codierschild mit Beschriftung, ohne Loch	Coding label, lettered, no hole
56-540-00-01	1	①	Lagerungsrack, Hohlschrauben-Set	Rack, cannulated screw set



Draht-Cerclage-System
Wire Cerclage System

71-83

St

Edelstahl
Stainless steel

5

VE = Verpackungseinheit
SU = Quantity/pack

Stahldraht, weich
Steel wire, soft

Länge
Length
10 m

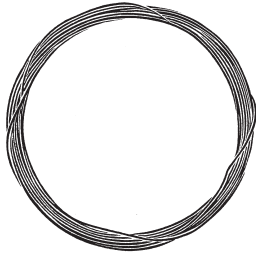

St 10

Ø	Art.-Nr. Item No.
0,2 mm	22-527-02-05
0,3 mm	22-527-03-05
0,4 mm	22-527-04-05
0,5 mm	22-527-05-05
0,6 mm	22-527-06-05
0,7 mm	22-527-07-05
0,8 mm	22-527-08-05
0,9 mm	22-527-09-05
1,0 mm	22-527-10-05
1,2 mm	22-527-12-05
1,5 mm	22-527-15-05

Kirschner

Trokarspitze
Trocar pointed



St 10

Ø	Länge/Length 60 mm / 2 3/8"	120 mm / 5"	140 mm / 5 4/8"	160 mm / 6 2/8"	310 mm / 12 2/8"
0,6 mm	22-622-06-05				
0,8 mm	22-622-08-05				
1,0 mm	22-622-10-05	22-626-10-05	22-628-10-05	22-630-10-05	22-632-10-05
1,2 mm	22-622-12-05	22-626-12-05	22-628-12-05	22-630-12-05	22-632-12-05
1,4 mm	22-622-14-05	22-626-14-05	22-628-14-05	22-630-14-05	22-632-14-05
1,5 mm	22-622-15-05	22-626-15-05	22-628-15-05	22-630-15-05	22-632-15-05
1,6 mm	22-622-16-05	22-626-16-05	22-628-16-05	22-630-16-05	22-632-16-05
1,8 mm	22-622-18-05	22-626-18-05	22-628-18-05	22-630-18-05	22-632-18-05
2,0 mm	22-622-20-05	22-626-20-05	22-628-20-05	22-630-20-05	22-632-20-05
2,2 mm	22-622-22-05	22-626-22-05	22-628-22-05	22-630-22-05	22-632-22-05
2,5 mm				22-630-25-05	22-632-25-05

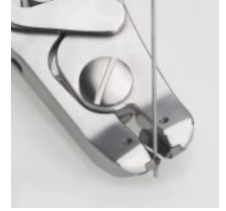

Kirschner 

Trokarspitze mit rundem Schaft
Trocar, pointed, with round end

St 10

Ø	Länge/Length 60 mm / 2 4/8"	100 mm / 3 7/8"	120 mm / 5"	140 mm / 5 4/8"	160 mm / 6 2/8"	310 mm / 12 2/8"
1,0 mm	22-623-10-05	22-625-10-05	22-627-10-05	22-629-10-05	22-631-10-05	22-633-10-05
1,2 mm	22-623-12-05	22-625-12-05	22-627-12-05	22-629-12-05	22-631-12-05	22-633-12-05
1,4 mm	22-623-14-05	22-625-14-05	22-627-14-05	22-629-14-05	22-631-14-05	22-633-14-05
1,5 mm	22-623-15-05		22-627-15-05	22-629-15-05	22-631-15-05	22-633-15-05
1,6 mm	22-623-16-05	22-625-16-05	22-627-16-05	22-629-16-05	22-631-16-05	22-633-16-05
1,8 mm	22-623-18-05		22-627-18-05	22-629-18-05	22-631-18-05	22-633-18-05
2,0 mm	22-623-20-05		22-627-20-05	22-629-20-05	22-631-20-05	22-633-20-05
2,2 mm	22-623-22-05		22-627-22-05	22-629-22-05	22-631-22-05	22-633-22-05
2,5 mm					22-631-25-05	22-633-25-05

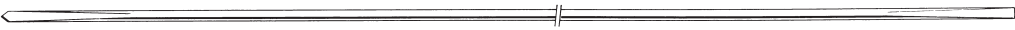
Kirschner 

Lanzenspitze
Lancet tip

St 10

Ø	Länge/Length 310 mm / 12 2/8"
1,0 mm	22-634-10-05
1,2 mm	22-634-12-05
1,5 mm	22-634-15-05
1,6 mm	22-634-16-05
1,8 mm	22-634-18-05
2,0 mm	22-634-20-05
2,2 mm	22-634-22-05
2,5 mm	22-634-25-05

Kirschner 

mit doppelter Spitze
double-tipped

St 10

Ø	Länge/Length 60 mm / 2 4/8"	120 mm / 5"	140 mm / 5 4/8"	160 mm / 6 2/8"	310 mm / 12 2/8"
0,6 mm	22-636-06-05	22-637-06-05			
0,8 mm	22-636-08-05	22-637-08-05	22-638-08-05		
1,0 mm	22-636-10-05	22-637-10-05	22-638-10-05	22-639-10-05	22-640-40-05
1,2 mm	22-636-12-05	22-637-12-05	22-638-12-05	22-639-12-05	22-640-42-05
1,4 mm	22-636-14-05	22-637-14-05	22-638-14-05	22-639-14-05	22-640-44-05
1,5 mm	22-636-15-05	22-637-15-05	22-638-15-05	22-639-15-05	22-640-45-05
1,6 mm	22-636-16-05	22-637-16-05	22-638-16-05	22-639-16-05	22-640-46-05
1,8 mm	22-636-18-05	22-637-18-05	22-638-18-05	22-639-18-05	22-640-48-05
2,0 mm	22-636-20-05	22-637-20-05	22-638-20-05	22-639-20-05	22-640-50-05
2,5 mm	22-636-25-05	22-637-25-05	22-638-25-05	22-639-25-05	22-640-55-05

TC GOLD



22-500-20-07
20 cm / 7 $\frac{7}{8}$ "
Drahtwirbelzange
Wire twisting forceps

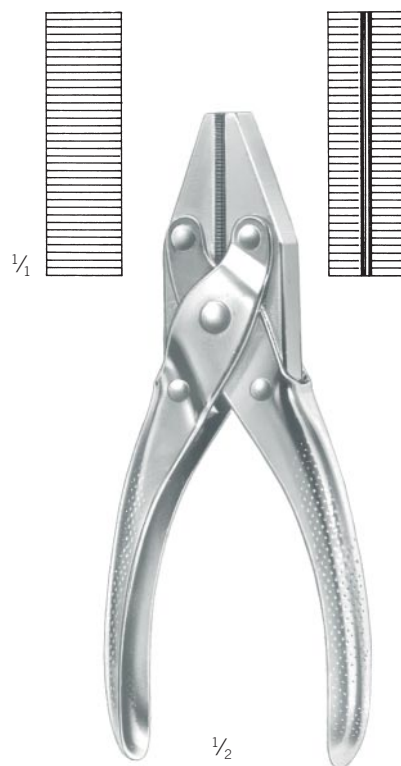

22-505-17-07
17 cm / 6 $\frac{6}{8}$ "
Flachzange
Flat nose pliers

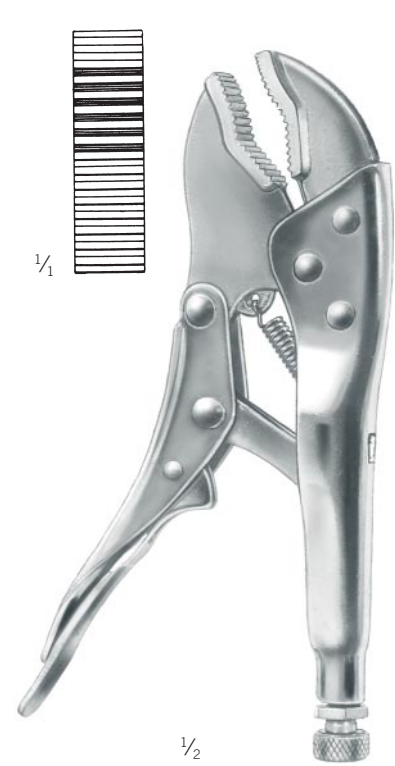

22-507-18-07
18 cm / 7 $\frac{1}{8}$ "
Tonnenzange
Vise grip

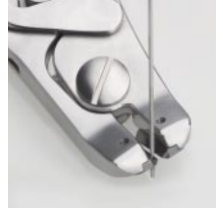

für weiche Drähte bis
for soft wires up to
Ø 2,2 mm
für harte Drähte bis
for hard wires up to
Ø 2,0 mm



Martin-Diamant
22-522-16-07
16 cm / 6 2/8"
Kopfschneider
Wire nippers

22-523-90-98

Ersatzblätter
Spare blades

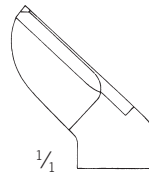

TC GOLD

für weiche Drähte bis
for soft wires up to
Ø 2,2 mm
für harte Drähte bis
for hard wires up to
Ø 2,8 mm

22-523-96-98

Ersatzfedern für 22-523-22
Spare springs for 22-523-22



22-523-22-07
22 cm / 8 5/8"
Seitenschneider
Side-cutting pliers

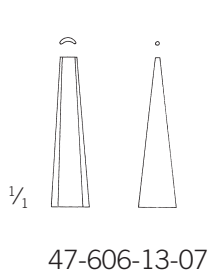

47-606-13-07

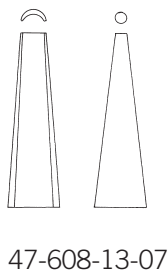

47-608-13-07

Schwarz
 47-606-13-07 -
 47-608-13-07
 16 cm / 6 2/8
 Drahtbiegezange
 Wire bending pliers



25-291-45-01
 45 mm
 Drahtumführungsinstrumente
 Bone wire guides

25-291-70-01
 70 mm

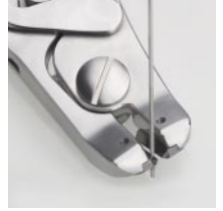

TC GOLD



22-511-01-07
18 cm / 7 1/8
Extraktionszange
Extracting forceps



Hackstock
22-518-16-07
16 cm / 6 2/8
Flachzange
Flat nose plier

TC GOLD



für weiche Drähte bis
for soft wires up to
Ø 2,0 mm
für harte Drähte bis
for hard wires up to
Ø 1,7 mm

22-523-16-07
18 cm / 7 1/8
Seitenschneider
Side-cutting pliers

TC GOLD



1/2

22-526-18-07

18 cm / 7 1/8"

Kopf- und Seitenschneider
Combination cutting pliers

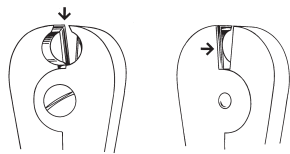

für weiche Drähte bis
for soft wires up to
Ø 2,0 mm

für harte Drähte bis
for hard wires up to
Ø 1,5 mm

TC GOLD

22-523-81-98



1/2

EasyCut
22-523-25-07

21,5 cm / 8 4/8"

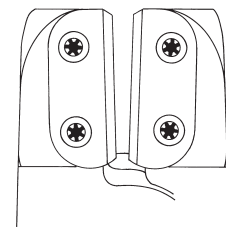

für weiche Drähte bis
for soft wires up to
Ø 2,2 mm

für harte Drähte bis
for hard wires up to
Ø 2,8 mm

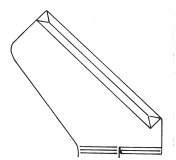

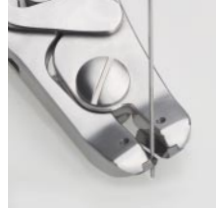

für Drähte bis
for wires up to
Ø 6,0 mm

22-528-00-07
55 cm / 21 2/8"
Plattenschneideinstrument
Plate cutter

22-618-90-98



zur Einbringung und Extraktion von K-Drähten
for insertion and extraction of K-wires
Ø 0,8 - 1,6 mm

Vickers Easidriver™
22-618-00-07
14 cm / 5 4/8"

Bohrdrahtspender

K-Wire Dispenser

55-730-90-98



- Vier verschiedene Bohrdrähte in einem Spender
 - Eindeutige Kennzeichnung der verschiedenen Durchmesser auf dem Spender
 - Sterilisation und Aufbewahrung im Spender möglich
 - Keine Verletzungsgefahr bei der Entnahme
 - Schutz der Bohrdrahtspitzen durch Teflon-Verschlusskappe
-
- A single dispenser with four different wire sizes
 - Sizes clearly marked on dispenser
 - Dispenser can be used for sterilization and storage
 - Safe handling
 - Wire tips protected by teflon cap

Mehrfach-Bohrdrahtspender Multiple K-wire dispenser

Art.-Nr. Item No.	Länge Length	Ø Drähte Ø Wires	Drahtlänge Wire length
55-730-00-01	12 cm / 4 6/8"	1,0 / 1,2 / 1,4 / 1,6 mm	10 cm
55-730-16-01	18,5 cm / 7 2/8"	1,0 / 1,2 / 1,4 / 1,6 mm	16 cm
55-730-31-01	35 cm / 14"	1,0 / 1,2 / 1,4 / 1,6 mm	31 cm
55-731-16-01	18,5 cm / 7 2/8"	1,8 / 2,0 / 2,2 / 2,5 mm	16 cm
55-731-31-01	35 cm / 14"	1,8 / 2,0 / 2,2 / 2,5 mm	31 cm

Vickers

mit weißem Kunststoffdeckel
with white plastic cap

ca.
1/2

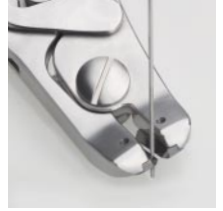

55-732-90-98



- Eindeutige Kennzeichnung des Drahtdurchmessers auf dem Spender
 - Sterilisation und Aufbewahrung im Spender möglich
 - Keine Verletzungsgefahr bei der Entnahme
 - Schutz der Bohrdrahtspitzen durch Teflon-Verschlusskappe
-
- Clear size markings on the dispenser
 - Sterilization and storage in the dispenser possible
 - No danger of injury by taking out
 - Drill points are protected by the cap made of teflon

Bohrdrahtspender, einzeln
K-wire dispenser, single

Art.-Nr. Item No.	Länge Length	Ø Drähte Ø Wires	Drahtlänge Wire length
55-732-08-01	18,5 cm / 7 2/8"	0,8 mm	16 cm
55-732-10-01	18,5 cm / 7 2/8"	1,0 mm	16 cm
55-732-12-01	18,5 cm / 7 2/8"	1,2 mm	16 cm
55-732-14-01	18,5 cm / 7 2/8"	1,4 mm	16 cm
55-732-15-01	18,5 cm / 7 2/8"	1,5 mm	16 cm
55-732-16-01	18,5 cm / 7 2/8"	1,6 mm	16 cm
55-732-18-01	18,5 cm / 7 2/8"	1,8 mm	16 cm
55-732-20-01	18,5 cm / 7 2/8"	2,0 mm	16 cm
55-732-22-01	18,5 cm / 7 2/8"	2,2 mm	16 cm
55-732-25-01	18,5 cm / 7 2/8"	2,5 mm	16 cm
55-734-08-01	33,5 cm / 13 2/8"	0,8 mm	31 cm
55-734-10-01	33,5 cm / 13 2/8"	1,0 mm	31 cm
55-734-12-01	33,5 cm / 13 2/8"	1,2 mm	31 cm
55-734-14-01	33,5 cm / 13 2/8"	1,4 mm	31 cm
55-734-15-01	33,5 cm / 13 2/8"	1,5 mm	31 cm
55-734-16-01	33,5 cm / 13 2/8"	1,6 mm	31 cm
55-734-18-01	33,5 cm / 13 2/8"	1,8 mm	31 cm
55-734-20-01	33,5 cm / 13 2/8"	2,0 mm	31 cm
55-734-22-01	33,5 cm / 13 2/8"	2,2 mm	31 cm
55-734-25-01	33,5 cm / 13 2/8"	2,5 mm	31 cm

mit weißem Kunststoffdeckel
with white plastic cap

Draht-Cerclage-Set

Wire Cerclage Set

St

Edelstahl
Stainless steel

5

VE = Verpackungseinheit
SU = Quantity/pack



25-200-00-04

Draht-Set
Wire Set

25-200-00-04			Draht-Set, komplett, bestehend aus:	Wire Set, complete, consisting of:
Art.-Nr. Item No.	Stückzahl/Set Quantity/set	VE SU	Bezeichnung	Designation
22-500-20-07	1	1	TC-Drahtwirbelzange	TC-wire twisting forceps
22-505-17-07	1	1	Parallel-Flachzange	Flat nose pliers, parallel
22-507-18-07	1	1	Tonnenzange	Holding pliers, vise grip
22-522-16-07	1	1	MARTIN-Diamant Kopfschneider	Martin-Diamant cutting pliers
22-523-22-07	1	1	TC-Seitenschneider	TC-side nipper
22-527-10-05	1	1	Cerclage-Draht, weich Ø 1,0 mm, 10 m	Cerclage wire Ø 1.0 mm, 10 m
22-527-15-05	1	1	Cerclage-Draht, weich Ø 1,5 mm, 10 m	Cerclage wire Ø 1.5 mm, 10 m
22-630-12-05	1	10	Kirschnerdraht, 1,2 x 160 mm	K-wire, 1.2 x 160 mm
22-630-15-05	2	10	Kirschnerdraht, 1,5 x 160 mm	K-wire, 1.5 x 160 mm
22-630-20-05	1	10	Kirschnerdraht, 2,0 x 160 mm	K-wire, 2.0 x 160 mm
22-630-25-05	1	10	Kirschnerdraht, 2,5 x 160 mm	K-wire, 2.5 x 160 mm
25-291-45-01	1	1	Drahtumführungsinstrument 45 mm	Wire passer 45 mm
25-291-70-01	1	1	Drahtumführungsinstrument 70 mm	Wire passer 70 mm
47-606-13-07	1	1	Drahtbiegezange Schwarz, M2	Wire bending pliers Schwarz, M2
55-732-12-01	1	1	Bohrdrahtspender Ø 1,2 mm, 18,5 cm	K-wire dispenser, Ø 1.2 mm, 18.5 cm
55-732-15-01	2	1	Bohrdrahtspender Ø 1,5 mm, 18,5 cm	K-wire dispenser, Ø 1.5 mm, 18.5 cm
55-732-20-01	1	1	Bohrdrahtspender Ø 2,0 mm, 18,5 cm	K-wire dispenser, Ø 2.0 mm, 18.5 cm
55-732-25-01	1	1	Bohrdrahtspender Ø 2,5 mm, 18,5 cm	K-wire dispenser, Ø 2.5 mm, 18.5 cm

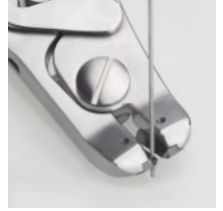

55-442-10-04
600 x 300 x 110 mm
MicroStop®-Container
MicroStop® container

25-200-00-04		Lagerung		Storage
Art.-Nr. Item No.	Stückzahl/Set Quantity/set	VE SU	Bezeichnung	Designation
55-442-10-04	1	①	MicroStop®-Container 600 x 300 x 110 mm	MicroStop® container 600 x 300 x 110 mm
55-443-12-04	2	①	Farbreiter, rot	Color tag, red
55-443-22-04	2	①	Codierschild mit Beschriftung, ohne Loch	Coding label, lettered, no hole
55-805-48-01	1	①	Siebkorb DIN, 480 x 255 x 33 mm	Sterilization tray DIN, 480 x 255 x 33 mm
55-996-56-04	1	①	Abdecktuch, OP-Grün, 1000 x 1300 mm	Covering towel, OR-green, 1000 x 1300 mm



DMS/DMS Intermediate

Das dynamische, winkeladaptierbare
Laschensystem

The dynamic, angle-adjustable
Barrel Plate System

85-100

St

Edelstahl
Stainless steel

1

VE = Verpackungseinheit
SU = Quantity/pack

Proximales Femur Proximal Femur

DMS-Platte
DMS Plate

Winkelstellung
Angle adjustment range
85°-145°

Laschenlänge
Tube length
34 mm

St 1



Löcher Holes	Art.-Nr. Item No.
1 mm	25-181-01-05
2 mm	25-181-02-05
4 mm	25-181-04-05
5 mm	25-181-05-05
6 mm	25-181-06-05
8 mm	25-181-08-05
10 mm	25-181-10-05
12 mm	25-181-12-05
14 mm	25-181-14-05
16 mm	25-181-16-05
18 mm	25-181-18-05

Kondyle / Knie Condyle / Knee

DMC-Platte
DMC Plate

Winkelstellung
Angle adjustment range
95°-115°

Laschenlänge
Tube length
24 mm

St 1



Löcher Holes	Art.-Nr. Item No.
2 mm	25-183-02-05
4 mm	25-183-04-05
6 mm	25-183-06-05
8 mm	25-183-08-05
10 mm	25-183-10-05
12 mm	25-183-12-05
14 mm	25-183-14-05
16 mm	25-183-16-05

DMS-Platte
DMS Plate

Winkelstellung
Angle adjustment range
85°-145°

Laschenlänge
Tube length
24 mm

St 1



Löcher Holes	Art.-Nr. Item No.
4 mm	25-182-04-05
6 mm	25-182-06-05
8 mm	25-182-08-05



Sechskant
Hexagon

Kortikalis-Schraube
Cortical Screw

Ø 4,5 mm

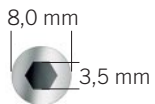

Länge Length	Art.-Nr. Item No.
30 mm	25-114-30-05
32 mm	25-114-32-05
34 mm	25-114-34-05
36 mm	25-114-36-05
38 mm	25-114-38-05
40 mm	25-114-40-05
42 mm	25-114-42-05
44 mm	25-114-44-05
46 mm	25-114-46-05
48 mm	25-114-48-05
50 mm	25-114-50-05
52 mm	25-114-52-05
56 mm	25-114-56-05
60 mm	25-114-60-05
64 mm	25-114-64-05
70 mm	25-114-70-05

Tragschrauben
Lag Screws

Ø 12,7 mm



Länge Length	Art.-Nr. Item No.
50 mm	25-180-50-05
55 mm	25-180-55-05
60 mm	25-180-60-05
65 mm	25-180-65-05
70 mm	25-180-70-05
75 mm	25-180-75-05
80 mm	25-180-80-05
85 mm	25-180-85-05
90 mm	25-180-90-05
95 mm	25-180-95-05
100 mm	25-180-00-05
105 mm	25-180-05-05
110 mm	25-180-10-05
115 mm	25-180-15-05
120 mm	25-180-20-05

Kompressionsschraube
Compression Screw

Ø 4,5 mm



Länge Length	Art.-Nr. Item No.
37 mm	25-180-99-05



mit AO-Ansatz
with AO attachment



VE = Verpackungseinheit
SU = Quantity/pack



Aluminium



1/2

25-238-00-05 **5**
22,5 cm / 8 7/8"
Ø 2,5 mm
Führungsdraht
Guide wire



1/2

25-238-05-07
20,5 cm / 8 1/8"
Messhülse
Measuring sleeve



1/2

25-238-13-07
22 cm / 8 5/8"
Dreistufenbohrer
mit 34-mm-Lasche
Combo reamer for lag screw
and 34-mm barre

25-238-12-07
22 cm / 8 5/8"
Dreistufenbohrer
mit 24-mm-Lasche
Combo reamer for lag screw
and 24-mm barre



1/2

25-238-18-04 **Al**
11 cm / 4 3/8"
Zentrierhülse (11 mm)
für 25-238-21-07
Centering sleeve (11 mm)
for 25-238-21-07

25-238-19-04 **Al**
Zentrierhülse
Centering sleeve



1/2

25-238-17-07
23 cm / 9"
Gewindeschneider
Tap

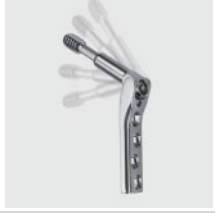

Sechskant
Hexagon



Ferrozell



1/2

25-238-06-07

21,5 cm / 8 4/8"

Tragschraubendreherhülse
Lag screw inserter



1/2

25-238-20-07

20 cm / 7 7/8"

Verbindungsanker
Lag screw connector



1/2

25-238-21-07

24 cm / 9 4/8"

Zusatzhülse für Schraubendreher
Safety inserter for screwdriver



1/2

25-268-35-07

25 cm / 9 7/8"

Schraubendreher für Schnecken-
getriebe sowie 4,5-mm-Kortikalis-
und 6,5-mm-Spongiosaschrauben

Screwdriver for worm drive
as well as 4.5-mm cortical screws
and 6.5-mm cancellous screws

25-238-25-04

Ersatzteil, einzeln
 Spare part, alone



1/2

25-238-14-07

20 cm / 7 7/8"

Platten-Einschläger
 Plate impactor



1/2

25-238-08-07

6,5 cm / 2 4/8"

T-Handgriff
 T-handle



1/2

25-212-45-01

14,5 cm / 5 5/8"

Gewebeschutzhülse
 Soft tissue sleeve

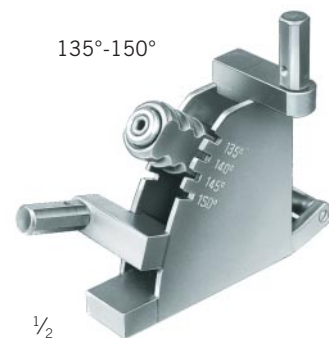

135°-150°

1/2

25-238-01-07

Zielgerät
 Aiming device

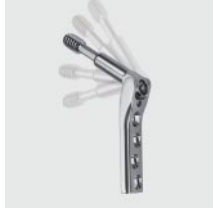

mit AO-Ansatz
with AO attachment

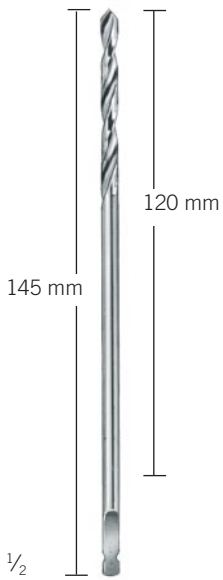

25-210-44-07 
Ø 4,5 mm
Spiralbohrer mit AO-Anschluss
für 6,5-mm-Spongiosaschrauben
Drill bit with AO attachment
for 6.5-mm cancellous screws

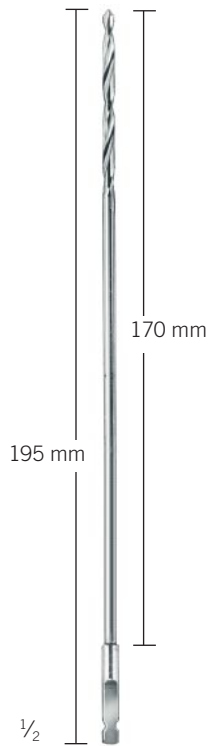

25-210-30-07 
Ø 3,2 mm
Spiralbohrer mit AO-Anschluss
für 4,5-mm-Spongiosaschrauben
Drill bit with AO attachment
for 4.5-mm cancellous screws



25-219-05-07
22 cm / 8 3/4"
Tiefenmesser, groß
Depth gauge, large



für Bohrer Ø 3,2 mm
for drill bit Ø 3.2 mm

35 mm

1/2
35 mm

25-222-44-01
16,5 cm / 6 1/2"
Bohrlehre neutral und exzentrisch
Drill bit guide, neutral and eccentric

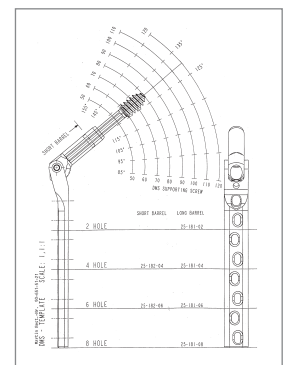

90-651-51-21
Röntgenschablone zur
präoperativen Planung
X-ray template for
preoperative planning

DMS-Set

DMS Set

St

Edelstahl
Stainless steel

1

VE = Verpackungseinheit
SU = Quantity/pack

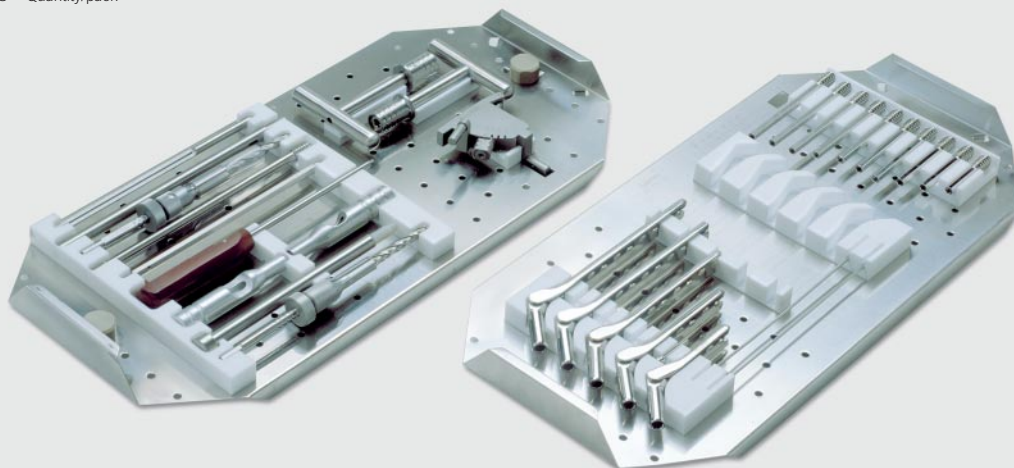

25-400-00-04
DMS-/DMC-Set
DMS/DMC Set

25-400-00-04			DMS-/DMC-Set, komplett, bestehend aus:	DMS/DMC Set, complete, consisting of:
Art.-Nr. Item No.	Stückzahl/Set Quantity/set	VE SU	Bezeichnung	Designation
22-368-35-07	1	1	Schraubendreher 3,5 mm, Inbus	Screwdriver 3.5 mm, hexagon
25-180-00-05	1	1	DMS-Tragschraube 100 mm	DMS lag screw 100 mm
25-180-10-05	1	1	DMS-Tragschraube 110 mm	DMS lag screw 110 mm
25-180-60-05	1	1	DMS-Tragschraube 60 mm	DMS lag screw 60 mm
25-180-70-05	1	1	DMS-Tragschraube 70 mm	DMS lag screw 70 mm
25-180-80-05	1	1	DMS-Tragschraube 80 mm	DMS lag screw 80 mm
25-180-85-05	1	1	DMS-Tragschraube 85 mm	DMS lag screw 85 mm
25-180-90-05	1	1	DMS-Tragschraube 90 mm	DMS lag screw 90 mm
25-180-95-05	1	1	DMS-Tragschraube 95 mm	DMS lag screw 95 mm
25-180-99-05	3	1	DMS-Kompressionsschraube	DMS compression screw
25-181-02-05	1	1	DMS-Platte, 2-Loch	DMS plate, 2-hole
25-181-04-05	1	1	DMS-Platte, 4-Loch	DMS plate, 4-hole
25-181-05-05	1	1	DMS-Platte, 5-Loch	DMS plate, 5-hole
25-181-06-05	1	1	DMS-Platte, 6-Loch	DMS plate, 6-hole
25-238-00-05	5	5	DMS-Führungsdraht	DMS guide wire
25-238-05-07	1	1	DMS-Messhülse	DMS measuring sleeve
25-238-06-07	1	1	DMS-Tragschraubendreher	DMS lag screwdriver
25-238-08-07	1	1	DMS-T-Handgriff	DMS T-handle
25-238-13-07	1	1	DMS-Dreistufenbohrer	DMS combo drill
25-238-14-07	1	1	DMS-Platteneinschläger	DMS driver
25-238-17-07	1	1	DMS-Gewindeschneider	DMS tap
25-238-18-04	1	1	DMS-Zentrierhülse	DMS centering sleeve
25-238-20-07	1	1	DMS-Verbindungsanker	DMS connection piece
25-238-21-07	1	1	DMS-Zusatzhülse für Tragschraubendreher	DMS additional sleeve for screw driver



55-442-13-04
600 x 300 x 140 mm
MicroStop®-Container
MicroStop® container

25-400-00-04		Lagerung		Storage
Art.-Nr. Item No.	Stückzahl/Set Quantity/set	VE SU	Bezeichnung	Designation
55-442-13-04	1	①	MicroStop®-Container 600 x 300 x 110 mm	MicroStop® container 600 x 300 x 110 mm
55-443-12-04	2	①	Farbreiter, rot	Color tag, red
55-443-22-04	2	①	Codierschild mit Beschriftung, ohne Loch	Coding label, lettered, no hole
55-550-60-01	1	①	DMS-Siebschale Implantate	DMS tray for implants
55-555-61-04	1	①	DMS-Siebschale Instrumente	DMS tray for instruments

Platten und Schrauben, DMS-Intermediate-Sortiment

Plates and screws, DMS Intermediate Portfolio

St

Edelstahl
Stainless steel

1

VE = Verpackungseinheit
SU = Quantity/pack

STERILE ⚠

dampfsterilisiert
steam sterilized

DMS-Intermediate-Platte DMS Intermediate Plate

Winkelstellung
Angle adjustment range
80°-110°

Laschenlänge
Tube length
19 mm



St

1

STERILE ⚠

Löcher Holes	Art.-Nr. Item No.
3 mm	25-178-03-05
4 mm	25-178-04-05
6 mm	25-178-06-05
8 mm	25-178-08-05

DMS-Intermediate-Platte DMS Intermediate Plate

Winkelstellung
Angle adjustment range
110°-145°

Laschenlänge
Tube length
19 mm



St

1

STERILE ⚠

Löcher Holes	Art.-Nr. Item No.
3 mm	25-179-03-05
4 mm	25-179-04-05
6 mm	25-179-06-05
8 mm	25-179-08-05



Sechskant
Hexagon

Kortikalis-Schraube
Cortical Screw

Ø 4,5 mm

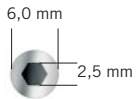

Länge Length	Art.-Nr. Item No.
16 mm	25-103-16-05
18 mm	25-103-18-05
20 mm	25-103-20-05
22 mm	25-103-22-05
24 mm	25-103-24-05
26 mm	25-103-26-05
28 mm	25-103-28-05
30 mm	25-103-30-05
32 mm	25-103-32-05
34 mm	25-103-34-05
36 mm	25-103-36-05
38 mm	25-103-38-05
40 mm	25-103-40-05
45 mm	25-103-45-05
50 mm	25-103-50-05
55 mm	25-103-55-05
60 mm	25-103-60-05

Tragschrauben
Lag Screws

Ø 9,5 mm



STERILE ↓

Länge Length	Art.-Nr. Item No.
35 mm	25-170-35-05
40 mm	25-170-40-05
45 mm	25-170-45-05
50 mm	25-170-50-05
55 mm	25-170-55-05
60 mm	25-170-60-05
65 mm	25-170-65-05
70 mm	25-170-70-05
75 mm	25-170-75-05
80 mm	25-170-80-05
85 mm	25-170-85-05
90 mm	25-170-90-05

Mini-Kompressionsschraube
Mini Compression Screw

Ø 3,5 mm

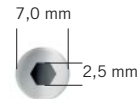

Länge Length	Art.-Nr. Item No.
25 mm	25-170-99-05



mit AO-Ansatz
 with AO attachment

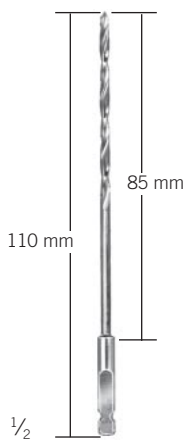

25-210-25-07 
 Ø 2,5 mm
 Spiralbohrer mit AO-Anschluss
 für 3,5 mm Kortikalisschrauben
 Drill bit with AO attachment
 for 3.5-mm cortical screws



25-210-30-07 
 Ø 3,2 mm
 Spiralbohrer mit AO-Anschluss
 für 4,0 mm Spongiosaschrauben
 Drill bit with AO attachment
 for 4.0-mm cancellous screws



25-219-04-07
 16 cm / 6 2/8"
 Tiefenmesser, klein
 Depth gauge, small

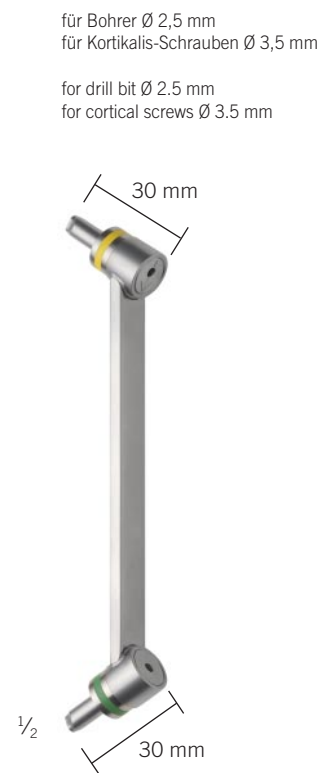

für Bohrer Ø 2,5 mm
 für Kortikalisschrauben Ø 3,5 mm
 for drill bit Ø 2.5 mm
 for cortical screws Ø 3.5 mm
 25-222-32-01
 14 cm / 5 1/8"
 Bohrlehre, neutral und exzentrisch
 Drill bit guide, neutral and eccentric

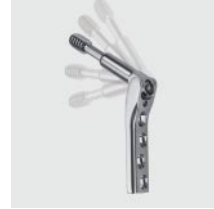

1/2

25-228-00-05 **5**
18 cm / 7"
Ø 2,0 mm
DMS-Intermediate-Führungsdraht
DMS Intermediate guide wire



1/2

25-228-05-07
15 cm / 6"
DMS-Intermediate-Messhülse
DMS Intermediate measuring sleeve



1/2

25-228-06-07
7 cm / 2 6/8"
DMS-Intermediate Tragschraubendreherhülse
DMS Intermediate lag screw inserter



1/2

25-228-20-07
9 cm / 3 4/8"
DMS-Intermediate-Verbindungsanker
DMS Intermediate lag screw connector



1/2

25-228-21-07
12,5 cm / 5"
DMS-Intermediate-Zusatzhülse für Schraubendreher
DMS Intermediate safety inserter for lag screw inserter



25-228-12-07

16 cm / 6 2/8"

DMS-Intermediate-
Dreistufenbohrer

DMS Intermediate
combo reamer



1/2

25-228-14-07

15 cm / 6"

DMS-Intermediate-
Platten-Einschläger

DMS Intermediate
plate impactor



1/2

25-228-17-07

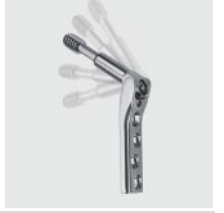

15 cm / 6"

DMS-Intermediate-Gewindeschneider
DMS Intermediate tap



25-238-08-07
6,5 cm / 2 1/8"
DMS-T-Handgriff
DMS T-handle



22-368-24-07  
24 cm / 9 1/8"
Schraubendreher für Schnecken-
getriebe sowie 3,5-mm-Kortikalis-
und 4,0-mm-Spongiaschrauben
Screwdriver for worm drive
as well as 3.5-mm cortical screws
and 4.0-mm cancellous screws

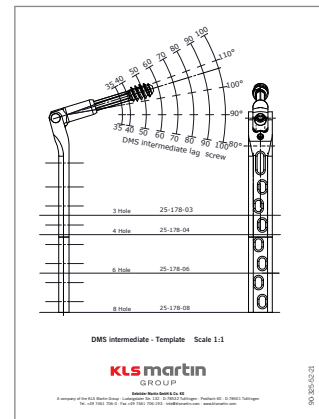

25-238-01-07
Röntgenschablone zur
präoperativen Planung
X-ray template for
preoperative planning

DMS-Intermediate-Set

DMS Intermediate Set

St

Edelstahl
Stainless steel

1

VE = Verpackungseinheit
SU = Quantity/pack

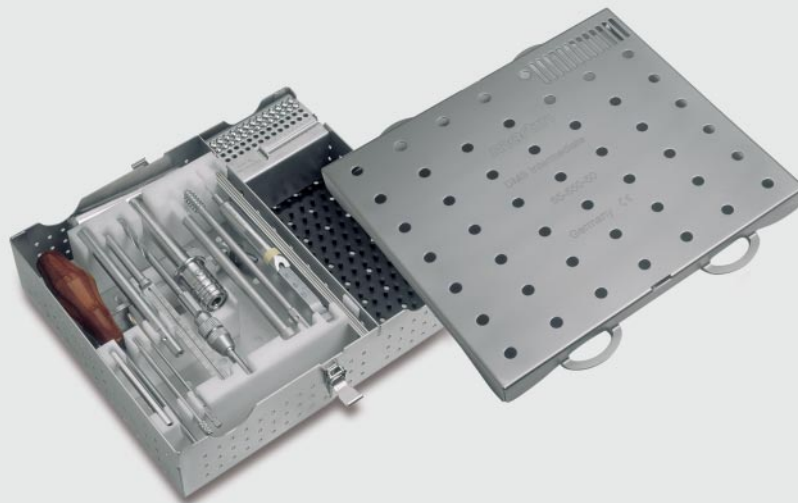

25-170-00-04
DMS-Intermediate-Set
DMS Intermediate Set

25-170-00-04			DMS-Intermediate-Set, komplett, bestehend aus:	DMS Intermediate Set, complete, consisting of:
Art.-Nr. Item No.	Stückzahl/Set Quantity/set	VE SU	Bezeichnung	Designation
22-368-24-07	1	1	Schraubendreher 2,5 mm, Inbus	Screwdriver 2.5 mm, hexagon
25-103-16-05	5	5	Kortikalisschraube Ø 3,5 x 16 mm	Corticalis screw Ø 3.5 mm x 16 mm
25-103-18-05	5	5	Kortikalisschraube Ø 3,5 x 18 mm	Corticalis screw Ø 3.5 mm x 18 mm
25-103-20-05	5	5	Kortikalisschraube Ø 3,5 x 20 mm	Corticalis screw Ø 3.5 mm x 20 mm
25-103-22-05	5	5	Kortikalisschraube Ø 3,5 x 22 mm	Corticalis screw Ø 3.5 mm x 22 mm
25-103-24-05	5	5	Kortikalisschraube Ø 3,5 x 24 mm	Corticalis screw Ø 3.5 mm x 24 mm
25-103-26-05	5	5	Kortikalisschraube Ø 3,5 x 26 mm	Corticalis screw Ø 3.5 mm x 26 mm
25-103-28-05	5	5	Kortikalisschraube Ø 3,5 x 28 mm	Corticalis screw Ø 3.5 mm x 28 mm
25-103-30-05	5	5	Kortikalisschraube Ø 3,5 x 30 mm	Corticalis screw Ø 3.5 mm x 30 mm
25-103-32-05	5	5	Kortikalisschraube Ø 3,5 x 32 mm	Corticalis screw Ø 3.5 mm x 32 mm
25-103-34-05	5	5	Kortikalisschraube Ø 3,5 x 34 mm	Corticalis screw Ø 3.5 mm x 34 mm
25-103-36-05	5	5	Kortikalisschraube Ø 3,5 x 36 mm	Corticalis screw Ø 3.5 mm x 36 mm
25-103-38-05	5	5	Kortikalisschraube Ø 3,5 x 38 mm	Corticalis screw Ø 3.5 mm x 38 mm
25-103-40-05	5	5	Kortikalisschraube Ø 3,5 x 40 mm	Corticalis screw Ø 3.5 mm x 40 mm
25-210-25-07	1	1	Spiralbohrer Ø 2,5 mm	Drill bit Ø 2.5 mm
25-219-04-07	1	1	Schraubenmessgerät klein	Depth gauge for small screws
25-222-32-01	1	1	Bohrbüchse für Ø 3,5 mm Schrauben	Drill guide for Ø 3.5-mm screws
25-228-00-05	5	5	DMS-Intermediate-Führungsdraht	DMS Intermediate guide wire
25-228-05-07	1	1	DMS-Intermediate-Messhülse	DMS Intermediate measuring sleeve
25-228-06-07	1	1	DMS-Intermediate-Tragschraubendreher	DMS Intermediate lag screw inserter
25-228-12-07	1	1	DMS-Intermediate-Dreistufenbohrer	DMS Intermediate combo reamer
25-228-14-07	1	1	DMS-Intermediate-Platteneinschläger	DMS Intermediate plate impactor
25-228-17-07	1	1	DMS-Intermediate-Gewindeschneider	DMS Intermediate tap
25-228-20-07	1	1	DMS-Intermediate-Verbindungsanker	DMS Intermediate lag screw connector
25-228-21-07	1	1	DMS-Intermediate-Zusatzhülse für Tragschraubendreher	DMS Intermediate safety inserter for lag screwdriver
25-238-08-07	1	1	DMS-T-Handgriff	DMS T-handle
55-550-50-01	1	1	DMS-Intermediate-Lagerung	DMS Intermediate storage



Winkelplatten-System
Angle Plates System

101-121

Winkelplatten-Sortiment

Angle Plates Portfolio

St

Edelstahl
Stainless steel

1

VE = Verpackungseinheit
SU = Quantity/pack



Nut
Groove

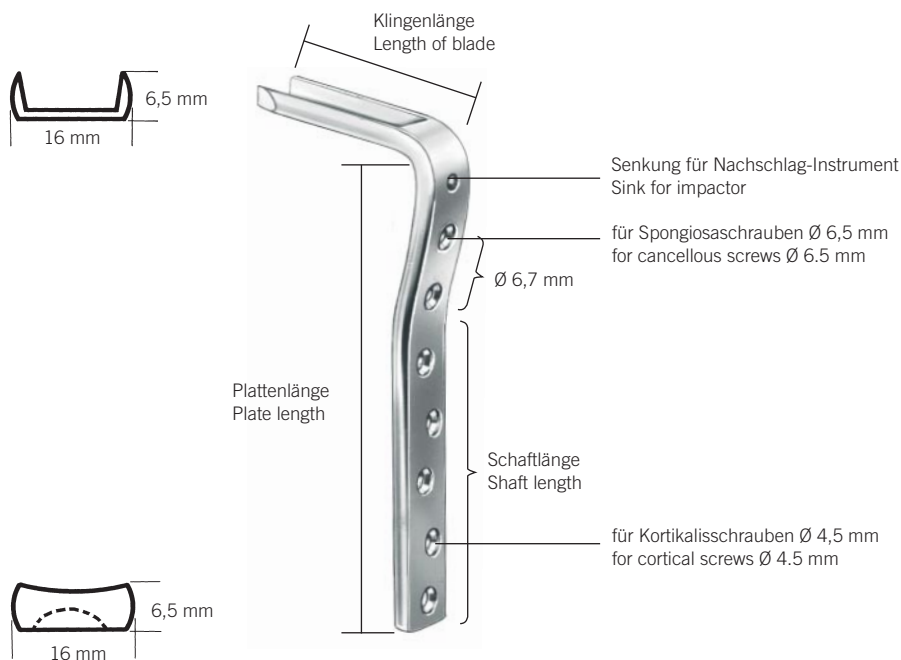

Indikation: Frakturen im distalen und proximalen Femurbereich, intertrochantere Valgisations-Osteotomie
Indication: Distal and proximal femoral fractures, intertrochanteric valgus osteotomy

Kondylenplatten 95° Condylar plates, 95°

St 1

Klingenlängen Blade lengths	Platten-/Schaftlängen Plate/Shaft lengths			
	92 mm/47 mm 5 Löcher/holes	124 mm/79 mm 7 Löcher/holes	156 mm/109 mm 9 Löcher/holes	204 mm/159 mm 12 Löcher/holes
50 mm	25-131-50-05	25-131-70-05	25-131-90-05	25-131-20-05
60 mm	25-131-52-05	25-131-72-05	25-131-92-05	25-131-22-05
70 mm	25-131-54-05	25-131-74-05	25-131-94-05	25-131-24-05
80 mm	25-131-56-05	25-131-76-05	25-131-96-05	25-131-26-05



Indikation: Mediale Schenkelhalsfrakturen
Indication: Medial fractures of the femoral neck

Winkelplatten mit Rundlöchern 130°
Angle plates with round holes, 130°

St 1

Klingenlängen Blade lengths	mit 1 Loch with 1 hole
70 mm	25-132-14-05
75 mm	25-132-15-05
80 mm	25-132-16-05
85 mm	25-132-17-05
90 mm	25-132-18-05
95 mm	25-132-19-05
100 mm	25-132-10-05
105 mm	25-132-11-05
110 mm	25-132-12-05

Winkelplatten-Sortiment

Angle Plates Portfolio

St

Edelstahl
Stainless steel

1

VE = Verpackungseinheit
SU = Quantity/pack



Nut
Groove

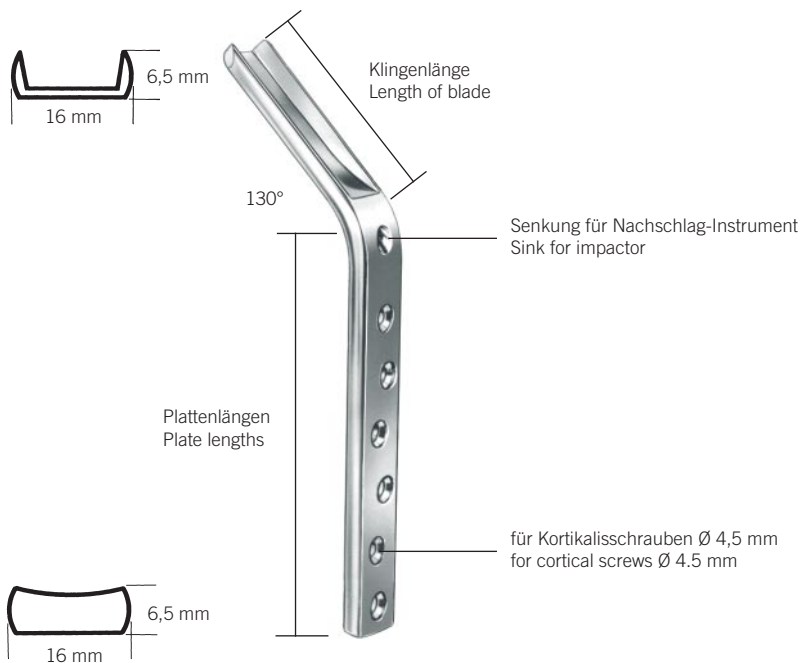

Indikation: Schenkelhals- und Petrochantere Frakturen
Indication: Femoral neck and petrochanteric fractures

Winkelplatten mit Rundlöchern 130° Angle plates with round holes, 130°

St 1

Klingenlängen Blade lengths	Plattenlängen Plate lengths
	60 mm 4 Löcher/holes
50 mm	25-133-36-05
60 mm	25-133-38-05
70 mm	25-133-44-05
75 mm	25-133-45-05
80 mm	25-133-46-05
85 mm	25-133-47-05
90 mm	25-133-48-05
95 mm	25-133-49-05
100 mm	25-133-40-05
105 mm	25-133-41-05
110 mm	25-133-42-05

Winkelplatten mit Rundlöchern 130° Angle plates with round holes, 130°

St 1

Klingenlängen Blade lengths	Plattenlängen Plate lengths		
	104 mm 6 Löcher/holes	152 mm 9 Löcher/holes	200 mm 12 Löcher/holes
50 mm	25-133-60-05		
60 mm	25-133-62-05		
70 mm	25-133-64-05	25-133-94-05	25-133-24-05
80 mm	25-133-66-05	25-133-96-05	25-133-26-05
90 mm	25-133-68-05	25-133-98-05	25-133-28-05

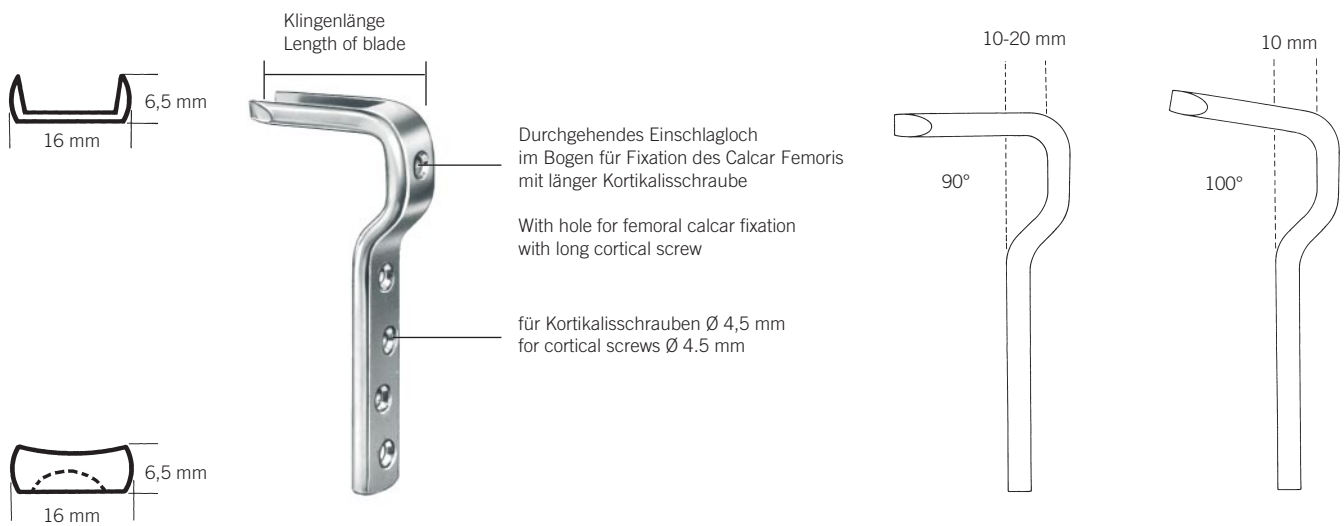

Indikation: Intertrochantere Femur-Osteotomien bei Erwachsenen
Indication: Intertrochanteric femoral osteotomies in adults

Winkelplatten mit Rundlöchern 90°
Angle plates with round holes, 90°



Klingenlängen Blade lengths	Bogentiefe Depth of bend	4 Löcher 4 holes
65 mm	10 mm	25-134-28-05
70 mm	15 mm	25-134-70-05
75 mm	15 mm	25-134-72-05
80 mm	20 mm	25-134-62-05

Winkelplatten mit Rundlöchern 100°
Angle plates with round holes, 100°



Klingenlängen Blade lengths	Bogentiefe Depth of bend	4 Löcher 4 holes
85 mm	10 mm	25-134-32-05

Winkelplatten-Sortiment

Angle Plates Portfolio

St

Edelstahl
Stainless steel

1

VE = Verpackungseinheit
SU = Quantity/pack



Nut
Groove

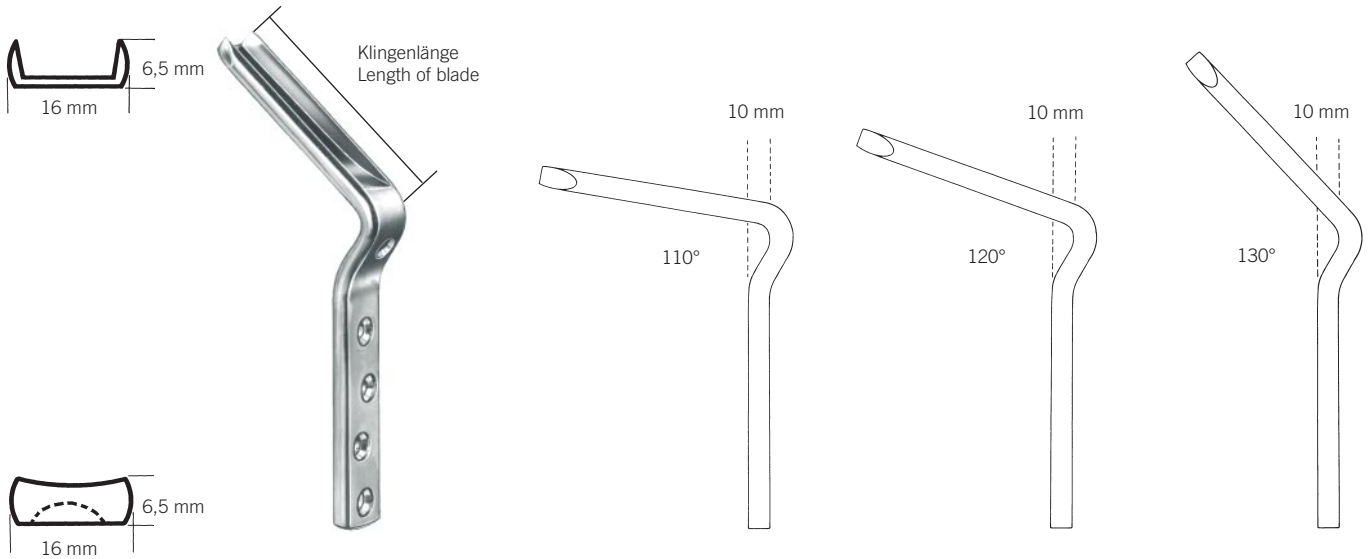

Indikation: Umlagerungsosteotomie bei Schenkelhalspseudarthrose und Schenkelhalsfrakturen

Indication: Displacement osteotomy for treatment of pseudarthrosis in the femoral neck and femoral neck fractures

Winkelplatten mit Rundlöchern 110°–130° Angle plates with round holes, 110°–130°

St 1

Klingenlängen Blade lengths	4 Löcher/holes 110°	4 Löcher/holes 120°	4 Löcher/holes 130°
65 mm	25-134-43-05	25-134-53-05	25-134-83-05
70 mm			25-134-84-05
75 mm	25-134-45-05	25-134-55-05	25-134-85-05
80 mm			25-134-86-05
85 mm	25-134-47-05	25-134-57-05	25-134-87-05
90 mm			25-134-88-05
95 mm			25-134-89-05
100 mm			25-134-80-05
105 mm			25-134-81-05
110 mm			25-134-82-05

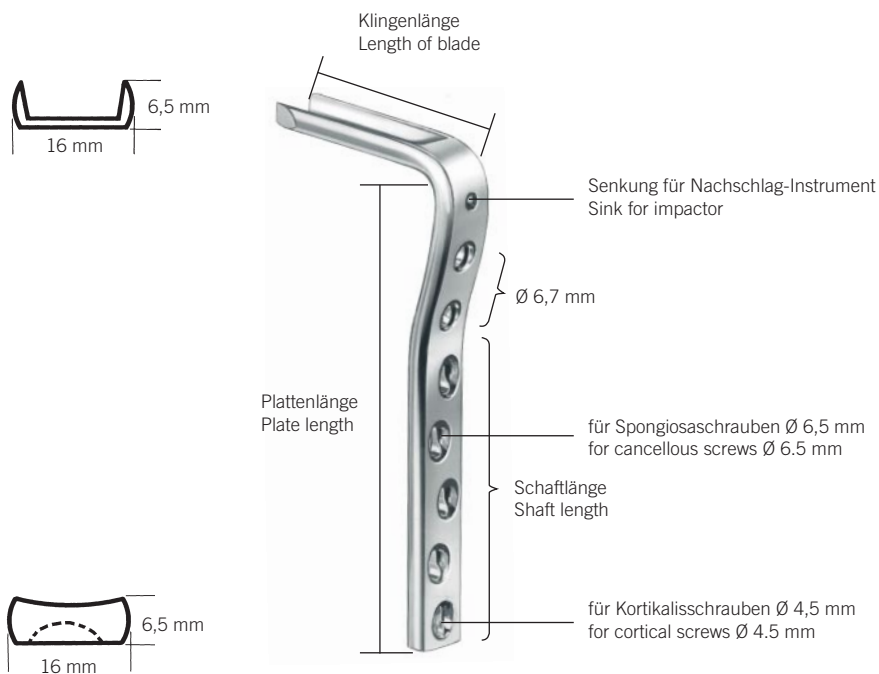

Indikation: Frakturen im distalen und proximalen Femurbereich,
intertrochantere Valgisations-Osteotomie

Indication: Distal and proximal femoral fractures, intertrochanteric
valgus osteotomy

Kondylenplatten 95° mit Kompressionslöchern
Condylar plates, 95° with compression holes



Klingenlängen Blade lengths	Platten-/Schaftlängen Plate/Shaft lengths			
	92 mm/49 mm 5 Löcher/holes	124 mm/82 mm 7 Löcher/holes	156 mm/112 mm 9 Löcher/holes	204 mm/158 mm 12 Löcher/holes
50 mm	25-137-50-05	25-137-70-05	25-137-90-05	25-137-20-05
60 mm	25-137-52-05	25-137-72-05	25-137-92-05	25-137-22-05
70 mm	25-137-54-05	25-137-74-05	25-137-94-05	25-137-24-05
80 mm	25-137-56-05	25-137-76-05	25-137-96-05	25-137-26-05

Winkelplatten-Sortiment

Angle Plates Portfolio

St

Edelstahl
Stainless steel

1

VE = Verpackungseinheit
SU = Quantity/pack



Nut
Groove

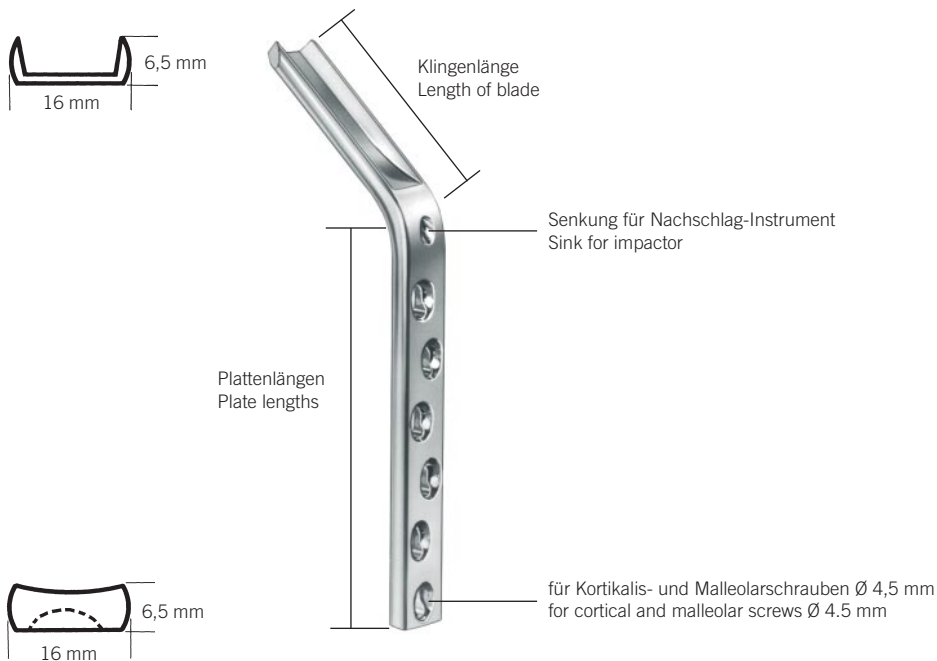

Indikation: Schenkelhals- und Petrochantere Frakturen
Indication: Femoral neck and petrochanteric fractures

Winkel-Kompressionsplatten 130° Angle Compression Plates, 130°

St 1

Klingenlängen Blade lengths	Plattenlängen Plate lengths
	60 mm 4 Löcher/holes
50 mm	25-138-36-05
60 mm	25-138-38-05
70 mm	25-138-44-05
75 mm	25-138-45-05
80 mm	25-138-46-05
85 mm	25-138-47-05
90 mm	25-138-48-05
95 mm	25-138-49-05
100 mm	25-138-40-05
105 mm	25-138-41-05
110 mm	25-138-42-05

Winkel-Kompressionsplatten 130° Angle Compression Plates, 130°

St 1

Klingenlängen Blade lengths	Plattenlängen Plate lengths		
	104 mm 6 Löcher/holes	152 mm 9 Löcher/holes	200 mm 12 Löcher/holes
50 mm	25-138-60-05		
60 mm	25-138-62-05		
70 mm	25-138-64-05	25-138-94-05	25-138-24-05
80 mm	25-138-66-05	25-138-96-05	25-138-26-05
90 mm	25-138-68-05	25-138-98-05	25-138-28-05

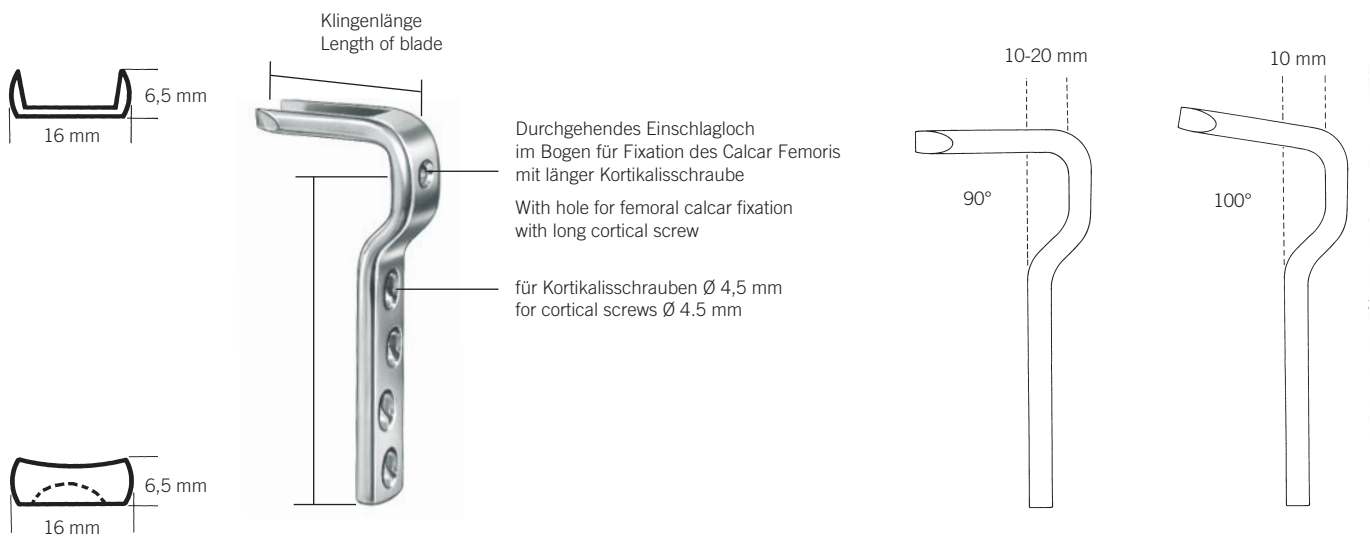

Indikation: Intertrochantere Femur-Osteotomien bei Erwachsenen
Indication: Intertrochanteric femoral osteotomies in adults

Winkel-Kompressionsplatten, 90°
Angle Compression Plates, 90°

St 1

Klingenlängen Blade lengths	Bogentiefe Depth of bend	4 Löcher 4 holes
40 mm	10 mm	25-139-28-05
50 mm	15 mm	25-139-70-05
60 mm	15 mm	25-139-72-05
60 mm	20 mm	25-139-62-05

Winkel-Kompressionsplatten, 100°
Angle Compression Plates, 100°

St 1

Klingenlängen Blade lengths	Bogentiefe Depth of bend	4 Löcher 4 holes
60 mm	10 mm	25-139-32-05

Winkelplatten-Sortiment

Angle Plates Portfolio

St

Edelstahl
Stainless steel

1

VE = Verpackungseinheit
SU = Quantity/pack



Nut
Groove

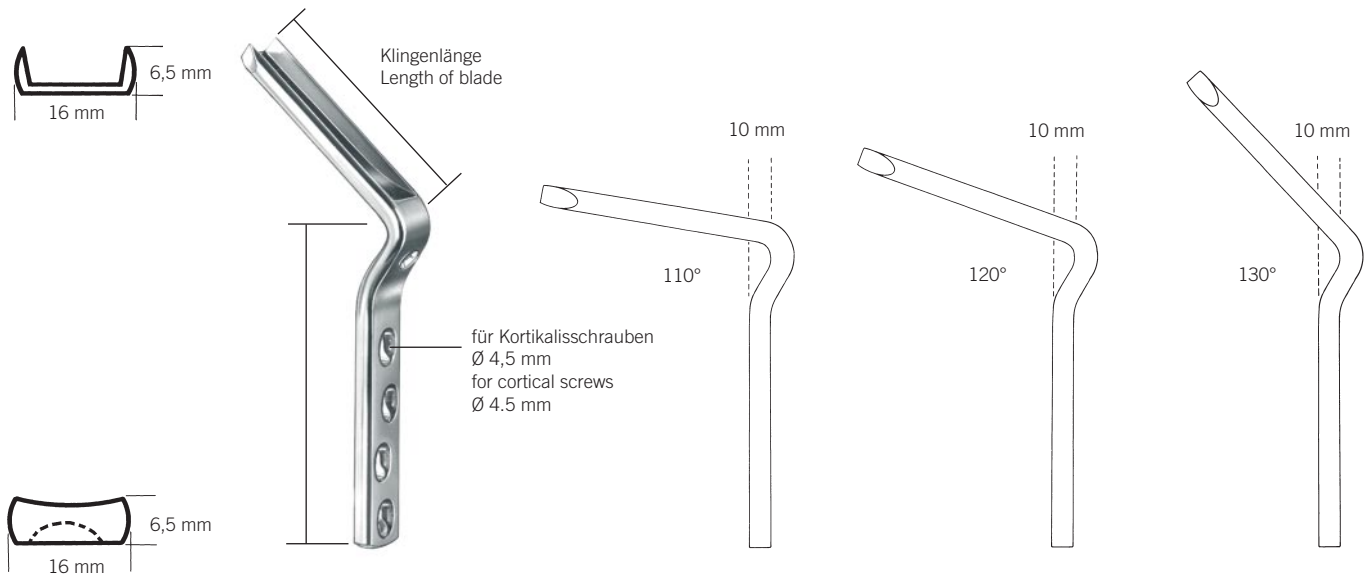

Indikation: Umlagerungsosteotomie bei Schenkelhalspseudarthrose und Schenkelhalsfrakturen

Indication: Displacement osteotomy for femoral-neck pseudarthrosis and fracture treatment

Winkel-Kompressionsplatten 110°–130° Angular compression plates, 110°–130°

St 1

Klingenlängen Blade lengths	4 Löcher/holes 110°	4 Löcher/holes 120°	4 Löcher/holes 130°
65 mm	25-139-43-05	25-139-53-05	25-139-83-05
70 mm			25-139-84-05
75 mm	25-139-45-05	25-139-55-05	25-139-85-05
80 mm			25-139-86-05
85 mm	25-139-47-05	25-139-57-05	25-139-87-05
90 mm			25-139-88-05
95 mm			25-139-89-05
100 mm			25-139-80-05
105 mm			25-139-81-05
110 mm			25-139-82-05

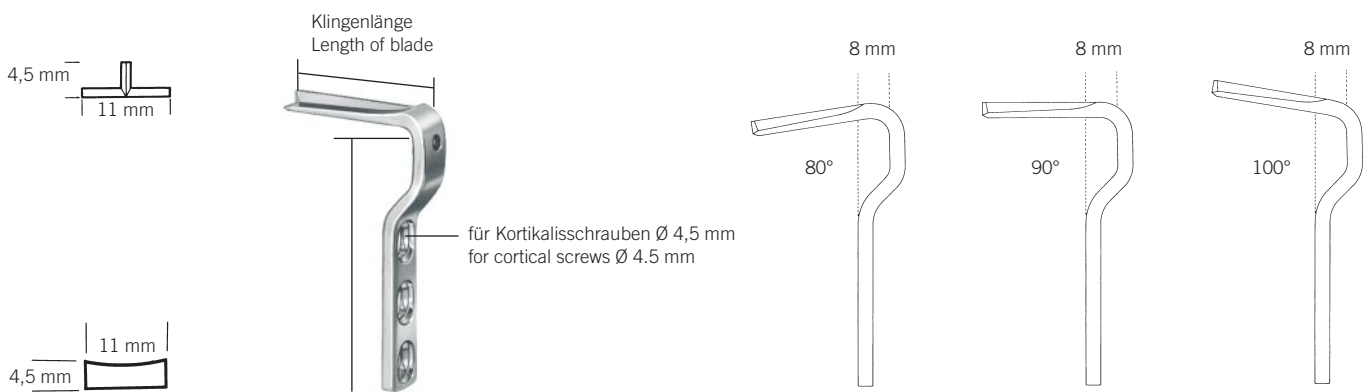

Indikation: Frakturen im distalen und proximalen Femurbereich,
intertrochantere Valgisations-Osteotomie

Indication: Distal and proximal femoral fractures,
intertrochanteric valgus osteotomy

Winkel-Kompressionsplatten 80°–100°
Angular compression plates, 80°–100°



Klingenlängen Blade lengths	3 Löcher/holes 80°	3 Löcher/holes 90°	3 Löcher/holes 100°
35 mm	25-135-17-05	25-135-27-05	25-135-37-05
45 mm	25-135-19-05	25-135-29-05	25-135-39-05

Winkelplatten-Sortiment

Angle Plates Portfolio

St

Edelstahl
Stainless steel

1

VE = Verpackungseinheit
SU = Quantity/pack



Indikation: Intertrochantere Femur-Osteotomien bei Jugendlichen
Indication: Intertrochanteric femoral osteotomies in adolescents

Winkel-Kompressionsplatten 90° Angular compression plates, 90°

St 1

Klingenlängen Blade lengths	Bogentiefe Depth of bend	3 Löcher/holes 90°
40 mm	10 mm	25-135-68-05
50 mm	10 mm	25-135-60-05
40 mm	15 mm	25-135-78-05
50 mm	15 mm	25-135-70-05

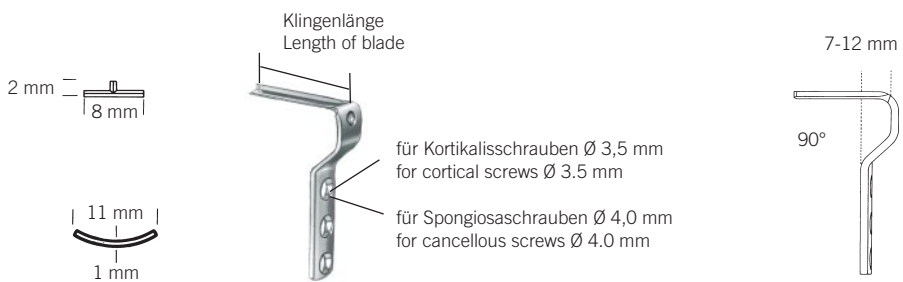

Indikation: Intertrochantere Femur-Osteotomien, Derotations- und Varus-Osteotomien bei Kindern bis zu 5 Jahren

Indication: Intertrochanteric femoral osteotomies, derotation and varus osteotomies in children up to 5 years old

**Winkel-Kompressionsplatten 90°
Angular compression plates, 90°**

St 1

Klingenlängen Blade lengths	Bogentiefe Depth of bend	3 Löcher/holes 90°
25 mm	7 mm	25-136-25-05
32 mm	7 mm	25-136-26-05
25 mm	12 mm	25-136-35-05
32 mm	12 mm	25-136-36-05



1/2

25-222-43-01

18 cm / 7 1/8"

Bohrbüchse für Kompressionsloch
Drill bit sleeve for compression hole



1/2

25-232-01-01

16 cm / 6 2/8"

Ø 4,5 mm

Zielgerät für Winkelplatten 130°
Aiming device for 130° angle plates



1/2

25-232-04-01

16 cm / 5 1/8"

Ø 3,2 mm

Bohrbüchse für Rundlochplatten
Drill bit sleeve for round-hole plates



mit AO-Ansatz
with AO attachment



1/2

25-232-05-07

9 cm / 3 5/8"

Ø 4 mm

Zapfenfräser

Reamer



1/2

25-232-06-07 

9 cm / 3 5/8"

Ø 4,5 mm

Zapfenfräser, AO-Ansatz

Reamer, AO attachment



1/2

25-232-09-07

8 cm / 3 1/8"

Führungsplatte für Winkelplatten-

Sitzinstrumente 22-232-12-07, -13-07, -14-07, -17-07

Sliding guide for seating chisel

22-232-12-07, -13-07, -14-07, -17-07

Instrumente, Winkelplatten-Sortiment

Instruments, Angle Plates Portfolio

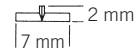
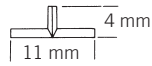
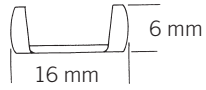
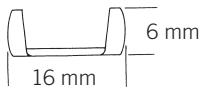

25-232-12-07

32 cm / 12 2/8"

Plattensitzinstrument für Erwachsene
Seating chisel for adults

25-232-13-07

28,5 cm / 12 2/8"

25-232-14-07

25 cm / 9 7/8"

für Kinder
for children

25-232-17-07

25 cm / 9 7/8"

für Kleinkinder
for small children

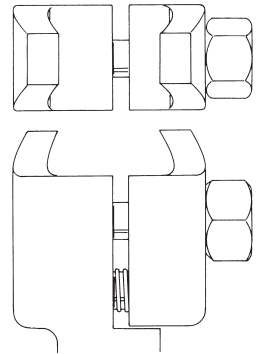

25-232-30-07
für Jugendliche, Platten 25-135-60-05 - 78-05
for adolescents, plates 25-135-60-05 - 78-05

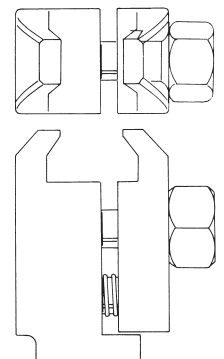

25-232-31-07
für Kinder, Platten 25-135-17-05 - 39-05
for children, plates 25-135-17-05 - 39-05

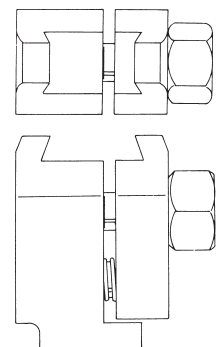

25-232-32-07
für Kleinkinder, Platten 25-136-25-05 - 36-05
for small children, plates 25-136-25-05 - 36-05



25-232-15-07
27 cm / 10 2/8"
Ein- und Ausschlaginstrument
Insertor - extractor



25-232-20-07
27 cm / 10 2/8"
Schlitzhammer
Slotted hammer



25-232-21-07
20,5 cm / 8 1/8"
Nachschlaginstrument
Impactor



25-232-30-07 -
25-232-32-07
27 cm / 10 2/8"
Einschlaginstrument
Insertor

Winkelzielplatten für Erwachsene
Positioning plates for adults

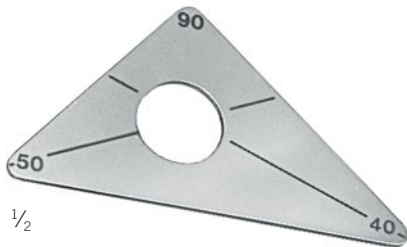

25-233-01-01
90° - 50° - 40°

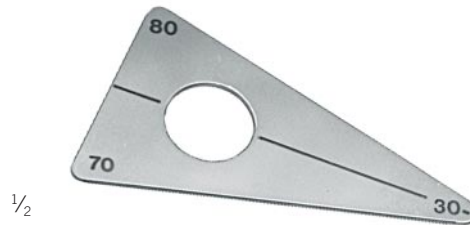

25-233-02-01
90° - 70° - 30°



25-233-03-01
100° - 60° - 20°



25-233-10-01
90° - 90° - 110° - 70°
Varisationsosteotomie-Zielgerät
Positioning plate for varus osteotomies



25-233-20-01
90° - 50° - 40°
Kondylen-Zielgerät
Condylar plate guide



Winkelzielplatten für Kinder
Positioning plates for children

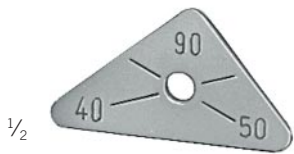

25-233-06-01
90° - 50° - 40°

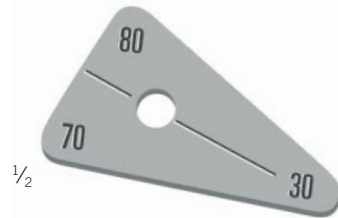

25-233-07-01
80° - 70° - 30°



25-233-08-01
100° - 60° - 20°

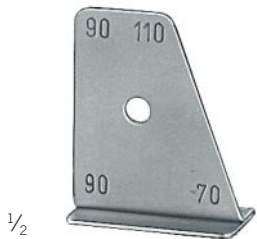

25-233-16-01
90° - 90° - 110° - 70°
Varisationsosteotomie-Zielgerät für Kinder
Positioning plate for osteotomies, for children

Instrumente, Winkelplatten-Set

Instruments, Angle Plates Set

St

Edelstahl
Stainless steel

5

VE = Verpackungseinheit
SU = Quantity/pack



25-300-00-04
Winkelplatten-Instrumente-Set
Angle plate instrument set

25-300-00-04			Winkelplatten-Instrumente-Set, komplett, bestehend aus:	Angle plate instrument Set, complete, consisting of:
Art.-Nr. Item No.	Stückzahl/Set Quantity/set	VE SU	Bezeichnung	Designation
25-222-43-01	1	1	Bohrbüchse für Kompressionsloch	Drill guide for compression hole
25-232-01-01	1	1	Zielgerät für Winkelplatten 130°	Aiming device for 130° angle plates
25-232-04-01	1	1	Bohrbüchse für Rundlochplatten	Drill guide for round-hole plates
25-232-05-07	1	1	Zapfenfräser Jakobsfutter	Reamer Jacobs chuck
25-232-06-07	1	1	Zapfenfräser AO-Kupplung	Reamer AO attachment
25-232-09-07	1	1	Führungsplatte für Winkelplattensetzer	Sliding guide for seating chisel
25-232-12-07	1	1	Plattensitzinstrument, extra lang	Seating chisel, extra long
25-232-13-07	1	1	Plattensitzinstrument, Erwachsene	Seating chisel, adult size
25-232-14-07	1	1	Plattensitzinstrument, Kinder	Seating chisel, child size
25-232-15-07	1	1	Winkelplatten-Ein- und Ausschläger	Impactor - Extractor
25-232-17-07	1	1	Plattensitzinstrument, Kleinkinder	Seating chisel, small children
25-232-20-07	1	1	Schlitzhammer	Slotted hammer
25-232-21-07	1	1	Nachschlag-Instrument	Impactor
25-232-30-07	1	1	Winkelplatten-Einschläger, Jugendliche	Impactor, adolescents
25-232-31-07	1	1	Winkelplatten-Einschläger, Kinder	Impactor, children
25-232-32-07	1	1	Winkelplatten-Einschläger, KleinKinder	Impactor, small children
25-233-01-01	1	1	Zielplatte 90-50-40°	Positioning plate 90-50-40°
25-233-02-01	1	1	Zielplatte 80-70-30°	Positioning plate 80-70-30°
25-233-03-01	1	1	Zielplatte 100-60-20°	Positioning plate 100-60-20°
25-233-06-01	1	1	Zielplatte Kinder 90-50-40°	Positioning plate children 90-50-40°
25-233-07-01	1	1	Zielplatte Kinder 80-70-30°	Positioning plate children 80-70-30°
25-233-08-01	1	1	Zielplatte Kinder 100-60-20°	Positioning plate children 100-60-20°
25-233-10-01	1	1	Varisationsosteotomiezielplatte 90-90-110-70°	Positioning plate for varus osteotomies 90-90-110-70°
25-233-16-01	1	1	Varisationsosteotomiezielplatte, Kinder 90-90-110-70°	Positioning plate for varus osteotomies children 90-90-110-70°
25-233-20-01	1	1	Kondylen-Zielgerät	Condylar plate guide



55-442-10-04
600 x 300 x 110 mm
MicroStop®-Container
MicroStop® container

25-300-00-04		Lagerung		Storage
Art.-Nr. Item No.	Stückzahl/Set Quantity/set	VE SU	Bezeichnung	Designation
55-442-10-04	1	①	MicroStop®-Container 600 x 300 x 110 mm	MicroStop® container 600 x 300 x 110 mm
55-443-12-04	2	①	Farbreiter, rot	Color tag, red
55-443-22-04	2	①	Codierschild mit Beschriftung, ohne Loch	Coding label, lettered, no hole
55-805-49-01	1	①	Siebkorb DIN, 480 x 255 x 53 mm	Tray DIN, 480 x 255 x 53 mm
55-807-48-04	1	①	Noppenmatte, 464 x 244 mm	Silicone mat, 464 x 244 mm
55-996-56-04	1	①	Abdecktuch, OP-Grün, 1000 x 1300 mm	Covering towel, OR-green, 1000 x 1300 mm



ISIS
Integriertes Schulter-Implantat-System
Integrated Shoulder Implant System

123-133

Schrauben und Platten, ISIS-Sortiment

Screws and Plates, ISIS Portfolio

Ti
Titan
Titanium

T-Drive

Multidirektional, winkelstabil
Multidirectional, locking

Schraubendurchmesser
Screw diameter
Ø 2,7 mm

Schraubendurchmesser
Screw diameter
Ø 3,5 mm

1
VE = Verpackungseinheit
SU = Quantity/pack

Winkelstabile Kortikalisschrauben Locking cortical screws

Ø 2,7 mm

Ø 3,5 mm



Länge Length	selbstschneidend self-tapping	selbstschneidend self-tapping
12 mm	26-502-12-09	26-504-12-09
14 mm	26-502-14-09	26-504-14-09
16 mm	26-502-16-09	26-504-16-09
18 mm	26-502-18-09	26-504-18-09
20 mm	26-502-20-09	26-504-20-09
22 mm	26-502-22-09	26-504-22-09
24 mm	26-502-24-09	26-504-24-09
26 mm	26-502-26-09	26-504-26-09
28 mm	26-502-28-09	26-504-28-09
30 mm	26-502-30-09	26-504-30-09
32 mm	26-502-32-09	26-504-32-09
34 mm	26-502-34-09	26-504-34-09
36 mm	26-502-36-09	26-504-36-09
38 mm	26-502-38-09	26-504-38-09
40 mm	26-502-40-09	26-504-40-09
42 mm	26-502-42-09	26-504-42-09
44 mm	26-502-44-09	26-504-44-09
46 mm	26-502-46-09	26-504-46-09
48 mm	26-502-48-09	26-504-48-09
50 mm	26-502-50-09	26-504-50-09

Standard-Schrauben Standard screws

Ø 2,7 mm

Ø 3,5 mm

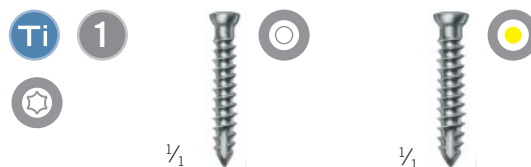

Länge Length	selbstschneidend self-tapping	selbstschneidend self-tapping
8 mm	26-901-08-09	26-903-08-09
10 mm	26-901-10-09	26-903-10-09
12 mm	26-901-12-09	26-903-12-09
14 mm	26-901-14-09	26-903-14-09
16 mm	26-901-16-09	26-903-16-09
18 mm	26-901-18-09	26-903-18-09
20 mm	26-901-20-09	26-903-20-09
22 mm	26-901-22-09	26-903-22-09
24 mm	26-901-24-09	26-903-24-09
26 mm	26-901-26-09	26-903-26-09
28 mm	26-901-28-09	26-903-28-09
30 mm	26-901-30-09	26-903-30-09
32 mm	26-901-32-09	26-903-32-09
34 mm	26-901-34-09	26-903-34-09
36 mm	26-901-36-09	26-903-36-09
38 mm	26-901-38-09	26-903-38-09
40 mm	26-901-40-09	26-903-40-09
42 mm	26-901-42-09	26-903-42-09
44 mm	26-901-44-09	26-903-44-09
46 mm	26-901-46-09	26-903-46-09
48 mm	26-901-48-09	26-903-48-09
50 mm	26-901-50-09	26-903-50-09
52 mm	26-901-52-09	26-903-52-09
54 mm	26-901-54-09	26-903-54-09
56 mm	26-901-56-09	26-903-56-09
58 mm	26-901-58-09	26-903-58-09
60 mm	26-901-60-09	26-903-60-09
62 mm	26-901-62-09	26-903-62-09
64 mm	26-901-64-09	26-903-64-09
66 mm	26-901-66-09	26-903-66-09
68 mm	26-901-68-09	26-903-68-09
70 mm	26-901-70-09	26-903-70-09



AC-Platte, kurz
AC plate, short



26-184-10-09 **Ti** 1
 = 2,5 mm
 rechts
 right

26-184-11-09 **Ti** 1
 = 2,5 mm
 links
 left

AC-Platte, lang
AC plate, long

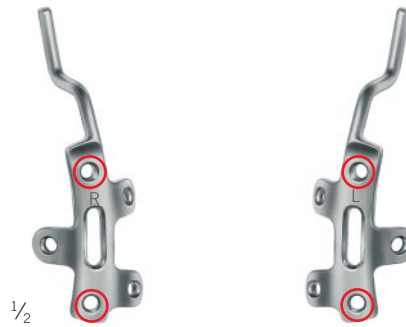

26-186-10-09 **Ti** 1
 = 2,5 mm
 rechts
 right

26-186-11-09 **Ti** 1
 = 2,5 mm
 links
 left

BC-Platte, kurz
BC plate, short

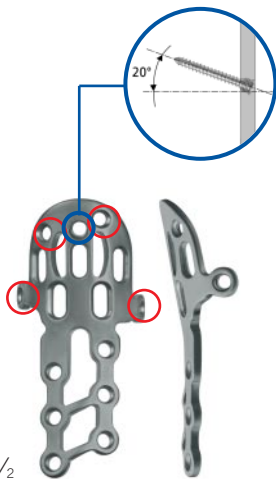

26-190-01-09 **Ti** 1
 = 2,5 mm
 rechts
 right

CC-Platte, kurz
CC plate, short

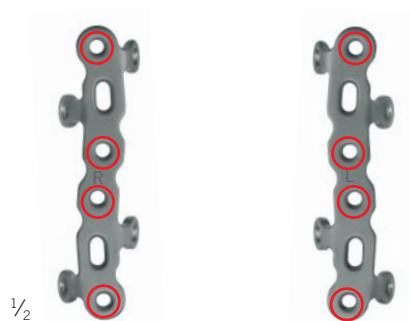

26-187-10-09 **Ti** 1
 = 2,5 mm
 rechts
 right

26-187-11-09 **Ti** 1
 = 2,5 mm
 links
 left

CC-Platte, lang
CC plate, long

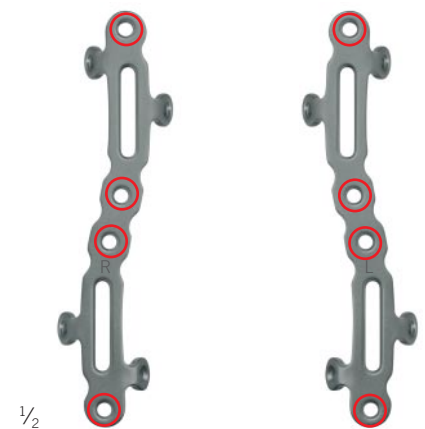

26-188-10-09 **Ti** 1
 = 2,5 mm
 rechts
 right

26-188-11-09 **Ti** 1
 = 2,5 mm
 links
 left



Schraubendurchmesser
 Screw diameter
 Ø 2,7 mm



Schraubendurchmesser
 Screw diameter
 Ø 3,5 mm



1/2

26-185-20-07
 16 cm / 6 3/8"
 Schränkeisen
 Bending iron



1/2

26-185-27-07 
 Ø 2,7 mm
 Zentrierhülse
 Centering sleeve



1/2

26-185-35-07 
 Ø 3,5 mm
 Zentrierhülse
 Centering sleeve



1/2

26-931-27-07 
 15 cm/6"
 Gewebeschutzhülse Ø 2,7 mm
 Soft-tissue sleeve Ø 2.7 mm





1/2

26-931-35-07 
 15 cm/6"
 Gewebeschutzhülse Ø 3,5 mm
 Soft-tissue sleeve Ø 3.5 mm



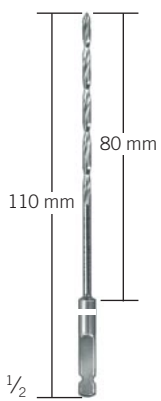

mit AO-Ansatz
with AO attachment

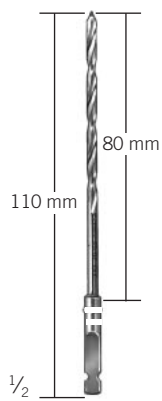

26-937-20-07  
 Ø 2,0 mm
 Kernlochbohrer
 Core hole drill



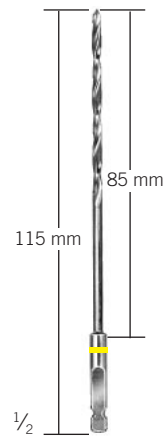

26-937-27-07  
 Ø 2,7 mm
 Gleitlochbohrer
 Gliding hole drill

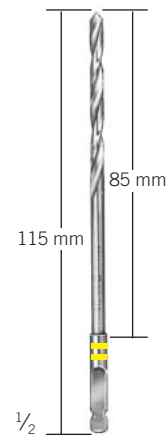

26-937-25-07  
 Ø 2,5 mm
 Kernlochbohrer
 Core hole drill



26-937-35-07  
 Ø 3,5 mm
 Gleitlochbohrer
 Gliding hole drill





Schraubendurchmesser
 Screw diameter
 Ø 2,7 mm



Schraubendurchmesser
 Screw diameter
 Ø 3,5 mm



1/2

26-938-27-07  
 11 cm / 4 3/8"
 Ø 2,7 mm
 Gewindeschneider, Kortikalis
 Tap, corticalis



1/2

26-938-35-07  
 11,5 cm / 4 1/2"
 Ø 3,5 mm
 Gewindeschneider, Kortikalis
 Tap, corticalis



1/2

26-945-00-07
 18 cm / 7 1/8"
 50 mm
 Tiefenmesser
 Depth gauge





T-Drive



Ferrozell



1/2



26-950-17-07  

16 cm / 6 3/8"

Schraubendreher
Screwdriver



1/2

26-453-17-07  

16 cm / 6 3/8"

Explantations-Schraubendreher
Explantation screwdriver



Schraubendurchmesser
Screw diameter
Ø 2,7 mm



Schraubendurchmesser
Screw diameter
Ø 3,5 mm

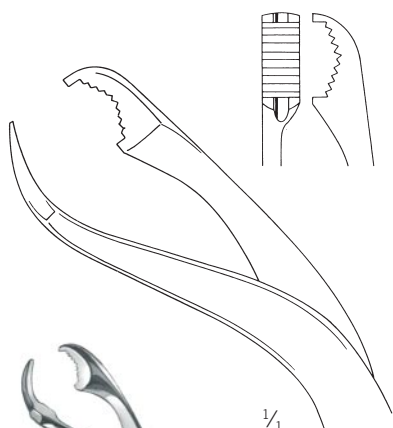

1/1



1/2

Verbrugge
23-757-01-07
17,5 cm/7"
Knochenhaltezange
Bone holding forceps



Bohrbüchse, exzentrisch
Drill bit guide, eccentric



26-933-27-07 Ø 2,7 mm

26-933-35-07 Ø 3,5 mm



Bohrbüchse, zentrisch
Drill bit guide, centric



26-934-27-07 Ø 2,7 mm

26-934-35-07 Ø 3,5 mm



1/2

26-142-00-07
11,5 cm / 4 1/8"
Griff für Bohrbüchsen
Handle for drill bit guides



1/2

26-185-10-07
26 cm / 10 1/8"
Biegezange
Plate bending pliers



mit AO-Ansatz
with AO attachment



1/2

26-935-27-07 
17,5 cm / 6 7/8"
Ø 2,7 mm
Plattenhalteinstrument
Plate holding instrument



1/2

26-935-35-07 
17,5 cm / 6 7/8"
Ø 3,5 mm
Plattenhalteinstrument
Plate holding instrument

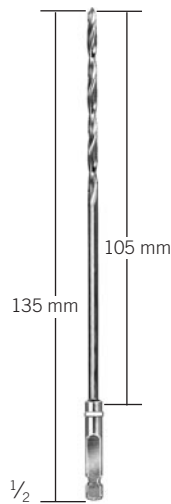

1/2

26-937-21-07  
Ø 2,0 mm
Kernlochbohrer
Core hole drill

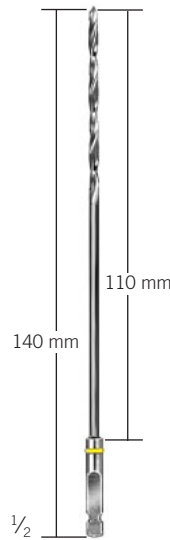

1/2

26-937-26-07  
Ø 2,5 mm
Kernlochbohrer
Core hole drill



1/2

26-945-70-07
18 cm/7" 70 mm
Tiefenmesser
Depth gauge

ISIS-Set

ISIS Set



Titan
Titanium



T-Drive



Multidirektional, winkelstabil
Multidirectional, locking



Schraubendurchmesser
Screw diameter
Ø 2,7 mm



Schraubendurchmesser
Screw diameter
Ø 3,5 mm



VE = Verpackungseinheit
SU = Quantity/pack



ISIS-Set
ISIS Set

26-180-00-04			Instrumente und Platten, ISIS-Set, komplett, bestehend aus:	Instruments and Plates, ISIS Set, complete, consisting of:
Art.-Nr. Item No.	Stückzahl/Set Quantity/set	VE SU	Bezeichnung	Designation
			ISIS-Platten	ISIS Plates
26-184-10-09	1	1	ISIS-AC-Platte kurz 4-Loch, Länge 71 mm, rechts	ISIS AC plate short, 4-hole, length 71 mm, right
26-184-11-09	1	1	ISIS-AC-Platte kurz 4-Loch, Länge 71 mm, links	ISIS AC plate short, 4-hole, length 71 mm, left
26-186-10-09	1	1	ISIS-AC-Platte lang 6-Loch, Länge 82 mm rechts	ISIS AC plate long, 6-hole, length 82 mm, right
26-186-11-09	1	1	ISIS-AC-Platte lang 6-Loch, Länge 82 mm links	ISIS AC plate long, 6-hole, length 82 mm, left
26-187-10-09	1	1	ISIS-CC-Platte kurz, Länge 77 mm rechts	ISIS CC plate short, length 77 mm, right
26-187-11-09	1	1	ISIS-CC-Platte kurz, Länge 77 mm links	ISIS CC plate short, length 77 mm, left
26-188-10-09	1	1	ISIS-CC-Platte lang, Länge 110 mm rechts	ISIS CC plate long, length 110 mm, right
26-188-11-09	1	1	ISIS-CC-Platte lang, Länge 110 mm links	ISIS CC plate long, length 110 mm, left
26-190-01-09	1	1	ISIS-BC-Platte, Länge 74 mm	ISIS BC plate, length 74 mm
			Instrumente	Instruments
26-931-27-07	1	1	Gewebeschutzhülse 2,7 mm	Tissue protection sleeve 2.7 mm
26-931-35-07	1	1	Gewebeschutzhülse 3,5 mm	Tissue protection sleeve 3.5 mm
26-937-20-07	1	1	Spiralbohrer Ø 2,0 mm	Drill bit Ø 2.0 mm
26-937-25-07	1	1	Spiralbohrer Ø 2,5 mm	Drill bit Ø 2.5 mm
26-937-27-07	1	1	Spiralbohrer Ø 2,7 mm	Drill bit Ø 2.7 mm
26-937-35-07	1	1	Spiralbohrer Ø 3,5 mm	Drill bit Ø 3.5 mm
26-938-27-07	1	1	Kortikalis-Gewindeschneider Ø 2,7 mm	Cortical tap Ø 2.7 mm
26-938-35-07	1	1	Kortikalis-Gewindeschneider Ø 3,5 mm	Cortical tap Ø 3.5 mm
26-945-60-07	1	1	Universal-Tiefenmesser	Universal depth gauge
26-950-11-07	1	1	AO-Handgriff	AO handle
26-952-00-07	1	1	T-Drive-Klinge AO	T-Drive screwdriver bit AO
26-185-20-07	2	1	ISIS-Schränkeisen	ISIS bending iron
26-185-27-07	1	1	ISIS-Zentrierhülse 2,7 mm	ISIS centering sleeve 2.7 mm
26-185-35-07	1	1	ISIS-Zentrierhülse 3,5 mm	ISIS centering sleeve 3.5 mm
			Lagerung	Storage
55-980-05-04	1	1	ISIS-Platten-/ Instrumentenlagerung	ISIS tray for plates and instruments
55-980-10-04	1	1	ISIS-Schraubenlagerung	ISIS tray for screws
55-980-74-07	1	1	ISIS-Platteninsert	ISIS insert for plates



T-Drive winkelstabile Schraube
T-Drive Locking screw



Ø 2,7 mm	Ø 3,5 mm	Länge Length	Stückzahl/Set Quantity/set
26-502-12-09	26-504-12-09	12 mm	3
26-502-14-09	26-504-14-09	14 mm	3
26-502-16-09	26-504-16-09	16 mm	3
26-502-18-09	26-504-18-09	18 mm	3
26-502-20-09	26-504-20-09	20 mm	3
26-502-22-09	26-504-22-09	22 mm	3
26-502-24-09	26-504-24-09	24 mm	3
26-502-26-09	26-504-26-09	26 mm	3
26-502-28-09	26-504-28-09	28 mm	3
26-502-30-09	26-504-30-09	30 mm	3
26-502-32-09	26-504-32-09	32 mm	3
26-502-34-09	26-504-34-09	34 mm	3
26-502-36-09	26-504-36-09	36 mm	3
26-502-38-09	26-504-38-09	38 mm	3
26-502-40-09	26-504-40-09	40 mm	3
26-502-42-09	26-504-42-09	42 mm	3
26-502-44-09	26-504-44-09	44 mm	3
26-502-46-09	26-504-46-09	46 mm	3
26-502-48-09	26-504-48-09	48 mm	3
26-502-50-09	26-504-50-09	50 mm	3

T-Drive Standard-Schraube
T-Drive standard screw



Ø 2,7 mm	Ø 3,5 mm	Länge Length	Stückzahl/Set Quantity/set
26-901-12-09	26-903-12-09	12 mm	5
26-901-14-09	26-903-14-09	14 mm	5
26-901-16-09	26-903-16-09	16 mm	5
26-901-18-09	26-903-18-09	18 mm	5
26-901-20-09	26-903-20-09	20 mm	5
26-901-22-09	26-903-22-09	22 mm	5
26-901-24-09	26-903-24-09	24 mm	5
26-901-26-09	26-903-26-09	26 mm	5
26-901-28-09	26-903-28-09	28 mm	5
26-901-30-09	26-903-30-09	30 mm	5
26-901-32-09	26-903-32-09	32 mm	5
26-901-34-09	26-903-34-09	34 mm	5
26-901-36-09	26-903-36-09	36 mm	5
26-901-38-09	26-903-38-09	38 mm	5
26-901-40-09	26-903-40-09	40 mm	5
26-901-42-09	26-903-42-09	42 mm	3
26-901-44-09	26-903-44-09	44 mm	3
26-901-46-09	26-903-46-09	46 mm	3
26-901-48-09	26-903-48-09	48 mm	3
26-901-50-09	26-903-50-09	50 mm	3



FOS
Vorfuß- und Rückfuß-
Osteosynthese-System
Forefoot and Hindfoot
Osteosynthesis System

135-148

Schrauben und Platten, FOS-Sortiment

Screws and Plates, FOS Portfolio



Titan
Titanium



T-Drive



Schraubendurchmesser
Screw diameter
Ø 2,7 mm



Schraubendurchmesser
Screw diameter
Ø 3,5 mm



VE = Verpackungseinheit
SU = Quantity/pack

Standard-Schrauben Standard Screws

Ø 2,7 mm



1/4

Länge
Length

selbstschneidend
self-tapping

8 mm	26-901-08-09
10 mm	26-901-10-09
12 mm	26-901-12-09
14 mm	26-901-14-09
16 mm	26-901-16-09
18 mm	26-901-18-09
20 mm	26-901-20-09
22 mm	26-901-22-09
24 mm	26-901-24-09
26 mm	26-901-26-09
28 mm	26-901-28-09
30 mm	26-901-30-09
32 mm	26-901-32-09
34 mm	26-901-34-09
36 mm	26-901-36-09
38 mm	26-901-38-09
40 mm	26-901-40-09
42 mm	26-901-42-09
44 mm	26-901-44-09
46 mm	26-901-46-09
48 mm	26-901-48-09
50 mm	26-901-50-09

Standard-Schrauben Standard Screws

Ø 3,5 mm



1/4

Länge
Length

selbstschneidend
self-tapping

8 mm	26-903-08-09
10 mm	26-903-10-09
12 mm	26-903-12-09
14 mm	26-903-14-09
16 mm	26-903-16-09
18 mm	26-903-18-09
20 mm	26-903-20-09
22 mm	26-903-22-09
24 mm	26-903-24-09
26 mm	26-903-26-09
28 mm	26-903-28-09
30 mm	26-903-30-09
32 mm	26-903-32-09
34 mm	26-903-34-09
36 mm	26-903-36-09
38 mm	26-903-38-09
40 mm	26-903-40-09
42 mm	26-903-42-09
44 mm	26-903-44-09
46 mm	26-903-46-09
48 mm	26-903-48-09
50 mm	26-903-50-09



26-901-00-09

Unterlegscheibe für
Washer for
Ø 2,7 mm



26-903-00-09

Unterlegscheibe für
Washer for
Ø 3,5 mm



Platten-Profil
Plate profile



Titan
Titanium



VE = Verpackungseinheit
SU = Quantity/pack

Vorfuß-Platten
Forefoot Plates

1/1



26-910-06-09
⌀ = 2,0 mm



26-910-08-09
⌀ = 2,0 mm



26-910-20-09
⌀ = 2,0 mm



26-910-30-09
⌀ = 2,0 mm



26-910-32-09
⌀ = 2,0 mm

1/1



26-910-40-09
⌀ = 2,0 mm



26-910-41-09
⌀ = 2,0 mm



26-910-50-09
⌀ = 2,0 mm



26-910-51-09
⌀ = 2,0 mm



Platten-Profil
Plate profile



Titan
Titanium



VE = Verpackungseinheit
SU = Quantity/pack

Kondylen-Platten
Kondylar Plates



1/1

26-910-10-09 **Ti** **1**
⌀ = 2,5 mm

26-910-11-09 **Ti** **1**
⌀ = 2,5 mm

26-910-12-09 **Ti** **1**
⌀ = 2,5 mm

26-910-13-09 **Ti** **1**
⌀ = 2,5 mm

Rückfuß-Platten
Hindfoot Plates

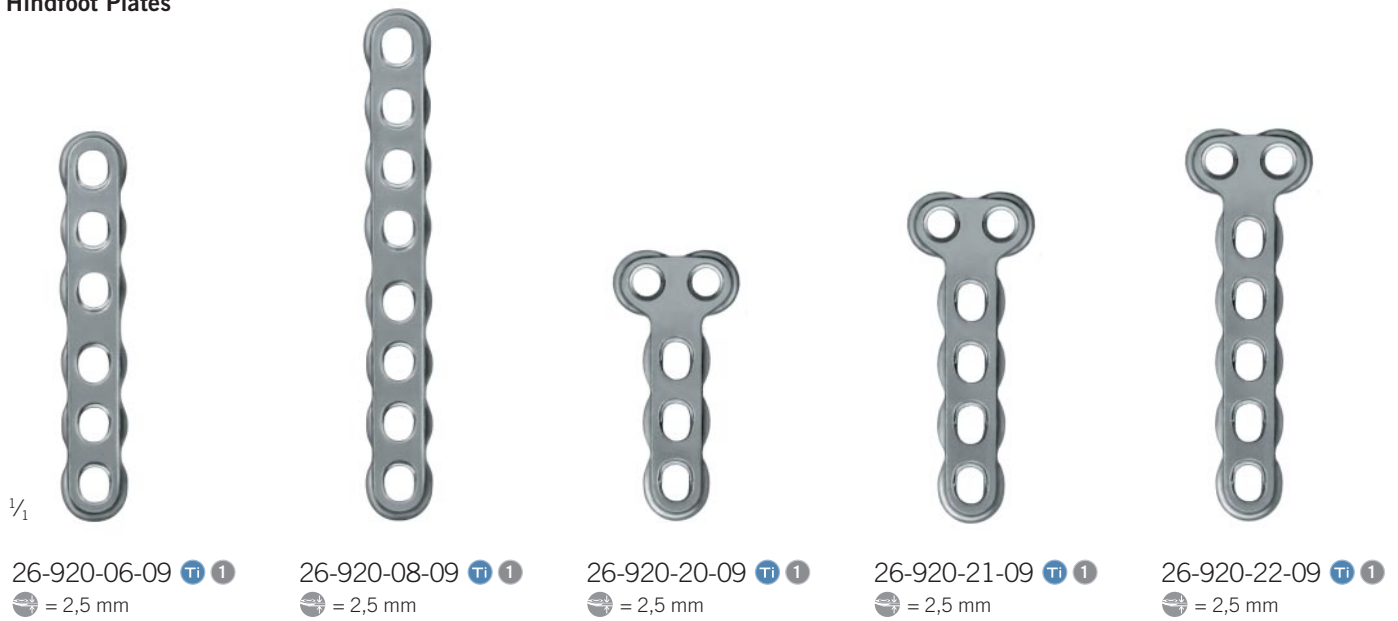

1/1

26-920-06-09 **Ti** **1**
⌀ = 2,5 mm

26-920-08-09 **Ti** **1**
⌀ = 2,5 mm

26-920-20-09 **Ti** **1**
⌀ = 2,5 mm

26-920-21-09 **Ti** **1**
⌀ = 2,5 mm

26-920-22-09 **Ti** **1**
⌀ = 2,5 mm



Rückfuß-Platten
Hindfoot Plates



26-920-50-09 **Ti** 1
⌀ = 2,5 mm



26-920-51-09 **Ti** 1
⌀ = 2,5 mm



26-920-60-09 **Ti** 1
⌀ = 2,5 mm



26-920-61-09 **Ti** 1
⌀ = 2,5 mm



26-920-80-09 **Ti** 1
⌀ = 2,5 mm



26-920-81-09 **Ti** 1
⌀ = 2,5 mm



26-920-90-09 **Ti** 1
⌀ = 2,5 mm



26-920-91-09 **Ti** 1
⌀ = 2,5 mm

Instrumente, FOS-Sortiment

Instruments, FOS Portfolio



mit AO-Ansatz
with AO attachment



Schraubendurchmesser
Screw diameter
Ø 2,7 mm



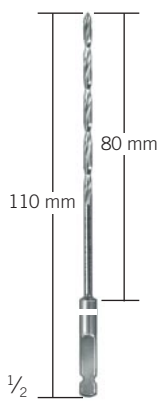

Schraubendurchmesser
Screw diameter
Ø 3,5 mm

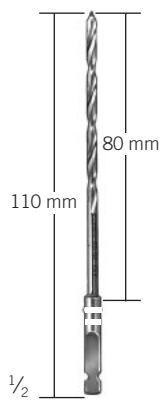

26-937-20-07  
Ø 2,0 mm
Kernlochbohrer
Core hole drill



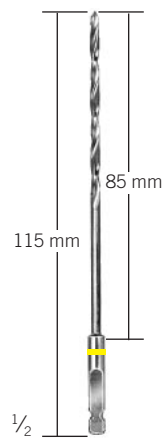

26-937-27-07  
Ø 2,7 mm
Gleitlochbohrer
Gliding hole drill

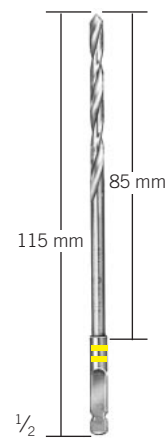

26-937-25-07  
Ø 2,5 mm
Kernlochbohrer
Core hole drill



26-937-35-07  
Ø 3,5 mm
Gleitlochbohrer
Gliding hole drill



Fz
Ferrozell



25-210-89-07 ⓘ
7 cm / 2 3/8"
Ø 2,0 mm
Kopfraumfräser
Countersink



26-938-27-07 ⓘ
10 cm / 3 7/8"
Ø 2,7 mm
Gewindeschneider, Kortikalis
Tap, cortical



26-938-35-07 ⓘ
11 cm / 4 3/8"
Ø 3,5 mm
Gewindeschneider, Kortikalis
Tap, cortical



25-211-43-07 ⓘ
11 cm / 4 3/8"
Handstück für AO-Ansatz
Handle for AO attachment



26-930-20-07-07
2,0/2,5 mm
Schränkeisen
Bending iron



26-930-21-07
2,5/2,0 mm
Schränkeisen
Bending iron



mit AO-Ansatz
with AO attachment



Schraubendurchmesser
Screw diameter
Ø 2,7 mm



Schraubendurchmesser
Screw diameter
Ø 3,5 mm



Bohrbüchse, exzentrisch
Drill bit guide, eccentric

- ⊙ 26-933-27-07 Ø 2,7 mm
- 26-933-35-07 Ø 3,5 mm



Bohrbüchse, zentrisch
Drill bit guide, centric

- ⊙ 26-934-27-07 Ø 2,7 mm
- 26-934-35-07 Ø 3,5 mm



26-931-27-07 ⊙
15 cm/6"
Gewebeschutzhülse Ø 2,7 mm
Soft-tissue sleeve Ø 2.7 mm



26-931-35-07 ●
15 cm/6"
Gewebeschutzhülse Ø 3,5 mm
Soft-tissue sleeve Ø 3.5 mm



26-142-00-07
11,5 cm / 4 1/8"
Griff für Bohrbüchsen
Handle for drill bit guides



26-935-27-07 ⊙
17,5 cm / 6 7/8"
Ø 2,7 mm
Plattenhalteinstrument
Plate holding instrument



26-935-35-07 ●
17,5 cm / 6 7/8"
Ø 3,5 mm
Plattenfasspinzette
Plate holding forceps



T-Drive



Ferrozell

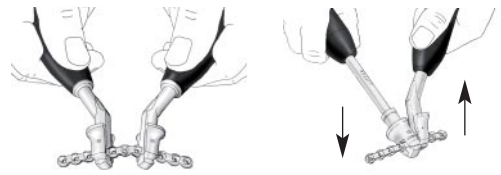



43-031-03-07
15 cm / 5 7/8"
Plattenfassspinzette
Plate holding forceps



26-945-60-07
18 cm / 7 1/8"
Tiefenmesser, universal
Depth gauge, universal



26-950-17-07  
16 cm / 6 3/8"
T-Drive-Schraubendreher
T-Drive screwdriver



26-930-10-07
19 cm / 7 5/8"
Biegeinstrument, rechts
Bending tool, right



26-930-11-07
19 cm / 7 5/8"
Biegeinstrument, links
Bending tool, left



T-Drive



1/2

25-410-00-07 ©
9 cm / 3 3/8"
Ratschenhandgriff für Schraubendreherklinge
Ratchet handle for screwdriver bit



1/2

26-948-00-07
Schraubendreherklinge
Screwdriver bit

25-406-99-07 ©
9 cm / 3 3/8"
Handgriff
Handle



1/2

50-124-16-07
16 cm / 6 3/8"
Biegezange
Plate bending pliers

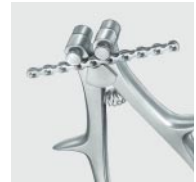
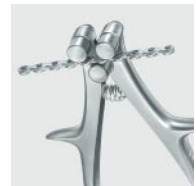



1/2



1/2

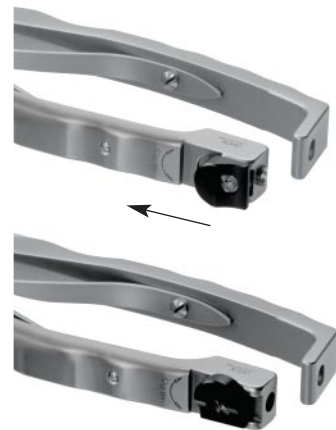

26-930-23-07

21,5 cm / 8 5/8"

Multifunktionszange, Ø 2,0/2,5 mm
Bender-cutter, Ø 2.0/2.5 mm

26-930-24-07

21,5 cm / 8 5/8"

Biegeinstrument, Ø 2,0/2,5 mm mit Rollen
Bending tool, Ø 2.0/2.5 mm with rollers

FOS-Set

FOS Set



Titan
Titanium



T-Drive



Schraubendurchmesser
Screw diameter
Ø 2,7 mm



Schraubendurchmesser
Screw diameter
Ø 3,5 mm



VE = Verpackungseinheit
SU = Quantity/pack

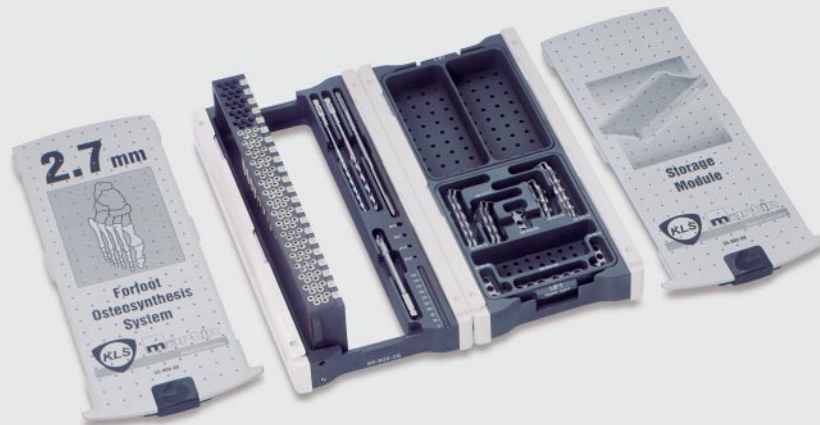

26-900-00-04





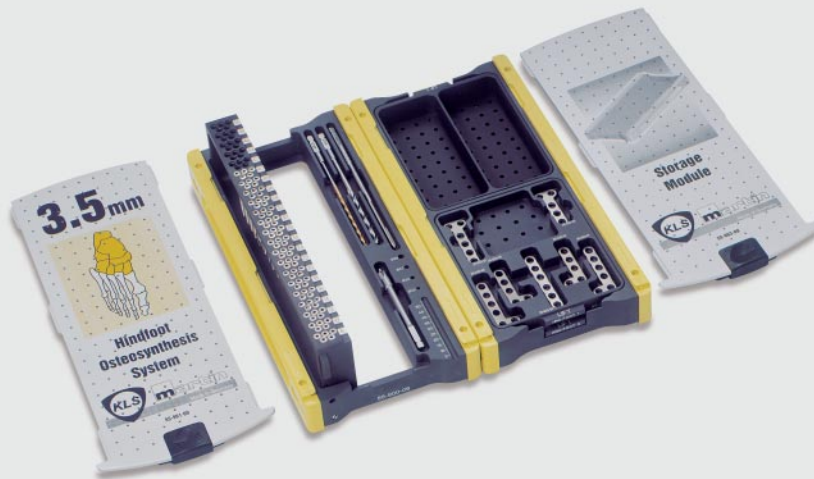

FOS-Vor- und Rückfuß-Set
FOS Forefoot and Hindfoot Set



T-Drive-Standardschraube T-Drive standard screw Ø 2,7 mm		
Art.-Nr. Item No.	Länge Length	Stückzahl/Set Quantity/set
26-901-08-09	8 mm	5
26-901-10-09	10 mm	5
26-901-12-09	12 mm	5
26-901-14-09	14 mm	5
26-901-16-09	16 mm	5
26-901-18-09	18 mm	5
26-901-20-09	20 mm	5
26-901-22-09	22 mm	5
26-901-24-09	24 mm	5
26-901-26-09	26 mm	5
26-901-28-09	28 mm	5
26-901-30-09	30 mm	5
26-901-32-09	32 mm	5
26-901-34-09	34 mm	5
26-901-36-09	36 mm	5
26-901-38-09	38 mm	5
26-901-40-09	40 mm	5
Unterlegscheibe / Washer		
26-901-00-09		5

FOS-Vorfuß-Platte FOS forefoot plate				
Art.-Nr. Item No.			Länge Length	Stückzahl/Set Quantity/set
26-910-06-09	gerade, 6-Loch	straight, 6-hole	47 mm	1
26-910-08-09	gerade, 8-Loch	straight, 8-hole	61 mm	1
26-910-20-09	T-Platte, 2/2-Loch	T-plate, 2/2-holes	24 mm	1
26-910-30-09	T-Platte, 2/4-Loch	T-plate, 2/4-holes	39 mm	1
26-910-40-09	L-Platte, 4-Loch, rechts	L-plate, 4-holes, right	22 mm	1
26-910-41-09	L-Platte, 4-Loch, links	L-plate, 4-holes, left	22 mm	1
26-910-50-09	L-Platte, 6-Loch, rechts	L-plate, 6-holes, right	37 mm	1
26-910-51-09	L-Platte, 6-Loch, links	L-plate, 6-holes, left	37 mm	1
FOS-Kondylenplatte FOS Condylar plate				
26-910-10-09	4-Loch, rechts	4-holes, right	36 mm	1
26-910-11-09	4-Loch, links	4-holes, left	36 mm	1
26-910-12-09	6-Loch, rechts	6-holes, right	53 mm	1
26-910-13-09	6-Loch, links	6-holes, left	53 mm	1



26-900-00-04
FOS-Vor- und Rückfuß-Set
FOS Forefoot and Hindfoot Set

T-Drive-Standardschraube T-Drive standard screw Ø 3,5 mm		   	
Art.-Nr. Item No.	Länge Length	Stückzahl/Set Quantity/set	
26-903-08-09	8 mm	5	
26-903-10-09	10 mm	5	
26-903-12-09	12 mm	5	
26-903-14-09	14 mm	5	
26-903-16-09	16 mm	5	
26-903-18-09	18 mm	5	
26-903-20-09	20 mm	5	
26-903-22-09	22 mm	5	
26-903-24-09	24 mm	5	
26-903-26-09	26 mm	5	
26-903-28-09	28 mm	5	
26-903-30-09	30 mm	5	
26-903-32-09	32 mm	5	
26-903-34-09	34 mm	5	
26-903-36-09	36 mm	5	
26-903-38-09	38 mm	5	
26-903-40-09	40 mm	5	
Unterlegscheibe / Washer		 	
26-903-00-09		5	

FOS-Rückfuß-Platte FOS hindfoot plate		  		
Art.-Nr. Item No.			Länge Length	Stückzahl/Set Quantity/set
26-920-06-09	gerade, 6-Loch	straight, 6-hole	52 mm	1
26-920-08-09	gerade, 8-Loch	straight, 8-hole	67 mm	1
26-920-20-09	T-Platte, 2/3-Loch	T-plate, 2/3-holes	36 mm	1
26-920-21-09	T-Platte, 2/4-Loch	T-plate, 2/4-holes	44 mm	1
26-920-22-09	T-Platte, 2/5-Loch	T-plate, 2/5-holes	52 mm	1
26-920-50-09	L-Platte, 5-Loch, rechts	L-plate, 5-holes, right	36 mm	1
26-920-51-09	L-Platte, 5-Loch, links	L-plate, 5-holes, left	36 mm	1
26-920-60-09	L-Platte, 6-Loch, rechts	L-plate, 6-holes, right	44 mm	1
26-920-61-09	L-Platte, 6-Loch, links	L-plate, 6-holes, left	44 mm	1
26-920-80-09	H-Platte, breit 4/4-Loch	H-plate, wide, 4/4-holes	37 mm	1
26-920-81-09	H-Platte, schmal 4/4-Loch	H-plate, narrow, 8-holes	37 mm	1
26-920-90-09	H-Doppelstegplatte, breit 4/4-Loch	double-bridge plate, wide, 4/4-holes	37 mm	1
26-920-91-09	H-Doppelstegplatte, schmal 4/4-Loch	double-bridge plate, narrow, 4/4-holes	37 mm	1

1

VE = Verpackungseinheit
SU = Quantity/pack



26-900-00-04
FOS-Vor- und Rückfuß-Set
FOS Forefoot and Hindfoot Set

26-900-00-04			Instrumente, FOS-Set, komplett, bestehend aus:	Instruments, FOS Set, complete, consisting of:
Art.-Nr. Item No.	Stückzahl/Set Quantity/set	VE SU	Bezeichnung	Designation
25-210-89-07	1	1	Kopfraumfräser Ø 2,0 mm	Countersink Ø 2.0 mm
25-211-43-07	1	1	Handstück für AO-Ansatz	Handle with AO attachment
26-142-00-07	1	1	Griff für Bohrführungen	Handle for drill guides
26-930-20-07	1	1	Schränkeisen 2,0/2,5 mm	Bending iron 2.0/2.5 mm
26-930-21-07	1	1	Schränkeisen 2,5/2,0 mm	Bending iron 2.5/2.0 mm
26-931-27-07	1	1	Gewebeschutzhülse 2,7 mm	Tissue protection sleeve 2.7 mm
26-931-35-07	1	1	Gewebeschutzhülse 3,5 mm	Tissue protection sleeve 3.5 mm
26-933-27-07	1	1	Bohrbüchse 2,7 mm exzentrisch	Drill bit guide 2.7 eccentric
26-933-35-07	1	1	Bohrbüchse 3,5 mm exzentrisch	Drill bit guide 3.5 eccentric
26-934-27-07	1	1	Bohrbüchse 2,7 mm zentrisch	Drill bit guide 2.7 centric
26-934-35-07	1	1	Bohrbüchse 3,5 mm zentrisch	Drill bit guide 3.5 centric
26-935-27-07	1	1	Plattenhalteinstrument 2,7 mm	Plate holding instrument 2.7 mm
26-935-35-07	1	1	Plattenhalteinstrument 3,5 mm	Plate holding instrument 3.5 mm
26-937-20-07	1	1	Spiralbohrer Ø 2,0 mm	Drill bit Ø 2.0 mm
26-937-25-07	1	1	Spiralbohrer Ø 2,5 mm	Drill bit Ø 2.5 mm
26-937-27-07	1	1	Spiralbohrer Ø 2,7 mm	Drill bit Ø 2.7 mm
26-937-35-07	1	1	Spiralbohrer Ø 3,5 mm	Drill bit Ø 3.5 mm
26-938-27-07	1	1	Kortikalis-Gewindeschneider Ø 2,7 mm	Cortical tap Ø 2.7 mm
26-938-35-07	1	1	Kortikalis-Gewindeschneider Ø 3,5 mm	Cortical tap Ø 3.5 mm
26-945-60-07	1	1	Universal-Tiefenmesser	Universal depth gauge
26-950-17-07	1	1	T-Drive-Schraubendreher	Screwdriver T-Drive
43-031-03-07	1	1	Plattenfasspinzette	Plate holding forceps

26-900-00-04			Lagerung	Storage
Art.-Nr. Item No.	Stückzahl/Set Quantity/set	VE SU	Bezeichnung	Designation
55-900-05-04	1	1	Lagerung weiß Ø 2,7 mm	Tray white Ø 2.7 mm
55-900-06-04	1	1	Lagerung gelb Ø 3,5 mm	Tray yellow Ø 3.5 mm
55-900-07-04	1	1	Lagerung für Vorfußplatten	Tray for forefoot plates
55-900-08-04	1	1	Lagerung für Rückfußplatten	Tray for hindfoot plates
55-900-10-04	1	1	Instrumententray	Instrument tray



Dynafix®
Externe Fixateur
External Fixator

149-158



1/1

26-580-01-04

Montiertes Gelenk, komplett
Mounted joint, complete

Der Farbcode unterscheidet die Gelenke wie folgt:

- blaue Gelenke für Kohlefaserstäbe
- goldene Gelenke für Stahlimplantate

The color codes distinguish the joints as follows:

- blue joints for carbon fiber rods
- golden joints for steel implants

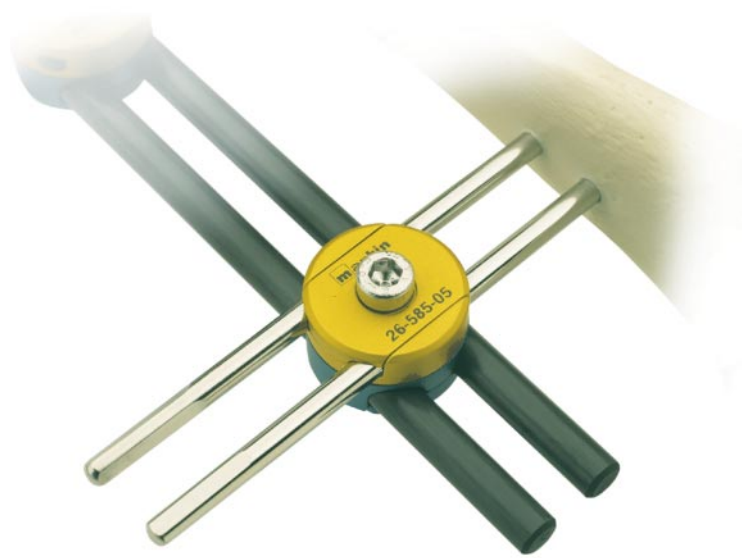

1/1

26-585-05-04

Oberteil
Upper part



1/1

26-585-15-04

Oberteil mit Gewinde
Upper part with thread



1/1

26-585-10-04

Unterteil mit Zahnung
Lower part with teeth



1/1

26-605-10-04

Halbschale mit Zahnung, 5 mm
Half-shell with teeth, 5 mm



26-590-05-04
Oberteil
Upper part



26-590-10-04
Oberteil mit Gewinde
Upper part, with thread



26-595-05-04
Oberteil mit Gewinde und Kennzeichnung
Upper part, with thread and identification



26-600-10-04
Unterteil
Lower part



26-600-05-04
Unterteil mit Zahnung
Lower section with teeth



26-605-05-04
Halbschale mit Zahnung, 5 mm
Half-shell with teeth, 5 mm



26-605-20-04
Halbschale mit Zahnung, 20 mm
Half-shell with teeth, 20 mm



1/1

26-610-00-04 - 26-610-50-04

Distanzscheiben, rot
 Spacer disk, red

- 26-610-00-04 = 1,0 mm
- 26-610-15-04 = 1,5 mm
- 26-610-25-04 = 2,5 mm
- 26-610-50-04 = 5,0 mm



26-620-10-07 - 26-620-60-07

Inbus-Schrauben
 Hex screws

- 26-620-10-07 = 10 mm
- 26-620-20-07 = 20 mm
- 26-620-25-07 = 25 mm
- 26-620-30-07 = 30 mm
- 26-620-50-07 = 50 mm
- 26-620-60-07 = 60 mm



1/1

26-646-00-04

Grundelement zur Kompression und Distraction
 Basic unit for compression and distraction



1/1

26-648-00-04

Oberteil ohne Kennzeichnung, für 26-646-00
 Upper part without identification, for 26-646-00



1/1

26-648-05-04

Oberteil mit Kennzeichnung, für 26-646-00
 Upper part with identification, for 26-646-00



26-615-10-04 -
26-615-45-04
Kohlefaserstäbe
Carbon fiber rods

- 26-615-10-04 = 100 mm
- 26-615-15-04 = 150 mm
- 26-615-20-04 = 200 mm
- 26-615-25-04 = 250 mm
- 26-615-30-04 = 300 mm
- 26-615-35-04 = 350 mm
- 26-615-40-04 = 400 mm
- 26-615-45-04 = 450 mm



26-630-08-05 -
26-630-20-05
Schanz'sche Schrauben
Schanz screws

- 26-630-08-05 = 80 mm
- 26-630-12-05 = 120 mm
- 26-630-15-05 = 150 mm
- 26-630-17-05 = 170 mm
- 26-630-20-05 = 200 mm



26-632-08-05 -
26-632-20-05
Schanz-Capretto-Schraube, selbstbohrend
Schanz-Capretto screw, self-drilling

- 26-632-08-05 = 80 mm
- 26-632-12-05 = 120 mm
- 26-632-15-05 = 150 mm
- 26-632-17-05 = 170 mm
- 26-632-20-05 = 200 mm



26-635-20-05 -
26-635-30-05
Steinmann-Nägeln
Steinmann pins

- 26-635-20-05 = 200 mm
- 26-635-25-05 = 250 mm
- 26-635-30-05 = 300 mm



26-636-18-05 -
26-636-20-05
Steinmann-Nägeln mit Mittelgewinde
Steinmann pins with central thread



26-624-00-04
Schutzkappe
Safety cap



mit AO-Ansatz
with AO attachment



Ferrozell



1/2

25-211-44-07
8,5 cm / 3 1/2"
T-Griffstück für AO-Ansatz
T-handle for AO attachment



1/2

26-570-15-07 - 
26-572-20-07
Spiralbohrer
Drills

26-570-15-07 = Ø 3,5/145 mm
26-570-20-07 = Ø 3,5/195 mm
25-572-15-07 = Ø 4,5/145 mm
26-572-20-07 = Ø 4,5/195 mm



1/2

26-642-00-07 
Handgriff für Gewebeschutzhülsen
Handle for drill bit guide



1/2

26-642-07-07 - 26-642-10-07
Gewebeschutzhülsen
Soft-tissue sleeves, for installation in joint

26-642-07-07 = 70 mm
26-642-10-07 = 100 mm

26-643-07-07 - 26-643-10-07
Gewebeschutzhülsen,
zur Aufnahme im Gelenk, Ø 5 mm
drill bit guides, for use through
the joint, Ø 5 mm

26-643-07-07 = 70 mm
26-643-10-07 = 100 mm



1/2

26-638-00-07
Inbus-Schlüssel, Ø 5 mm
Hex wrench, Ø 5 mm



1/2

26-655-50-07 
Kardanschlüssel, Ø 5 mm
Cardan wrench, Ø 5 mm



1/2

26-660-05-07
Kombi-Instrument, Ø 5 mm
Combination instrument, Ø 5 mm

Dynafix®-Set komplett

Set complete

St

Edelstahl
Stainless steel

1

VE = Verpackungseinheit
SU = Quantity/pack

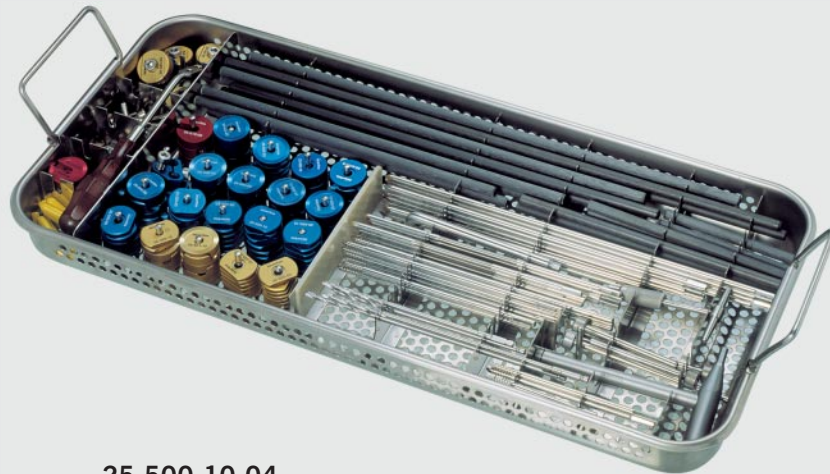

25-500-10-04

Dynafix®-Set
Dynafix® Set

25-500-10-04			Dynafix®-Set, komplett, bestehend aus:	Dynafix® Set, complete, consisting of:
Art.-Nr. Item No.	Stückzahl/Set Quantity/set	VE SU	Bezeichnung	Designation
26-580-01-04	4	1	Montiertes Gelenk	Mounted joint
26-585-05-04	12	1	Gelenkoberteil, gold	Joint, upper part, gold
26-585-10-04	12	1	Gelenkunterteil, gold, mit Zahnung	Joint, lower part, gold, with teeth
26-585-15-04	6	1	Gelenkoberteil, gold, mit Gewinde	Joint, upper part, gold, with thread
26-590-05-04	6	1	Gelenkoberteil, blau	Joint, upper part, blue
26-590-10-04	18	1	Gelenkoberteil, blau, mit Gewinde	Joint, upper part, blue, with thread
26-595-05-04	6	1	Gelenkoberteil, blau, mit Gewinde und Kennzeichnung	Joint, upper part, blue, with thread and identification
26-600-05-04	20	1	Gelenkunterteil, blau, mit Zahnung	Joint, lower part, blue, with teeth
26-600-10-04	8	1	Gelenkunterteil, blau	Joint, lower part, blue
26-605-05-04	6	1	Halbschale, blau, mit Zahnung, 5 mm	Half-shell, blue, with teeth 5 mm
26-605-10-04	6	1	Halbschale, gold, mit Zahnung, 5 mm	Half-shell, gold, with teeth 5 mm
26-605-20-04	2	1	Halbschale, blau, mit Zahnung, 20 mm	Half-shell, blue, with teeth 20 mm
26-610-00-04	3	1	Distanzscheibe rot, 1,0 mm	Washer, red 1.0 mm
26-610-15-04	3	1	Distanzscheibe rot, 1,5 mm	Washer, red 1.5 mm
26-610-25-04	3	1	Distanzscheibe rot, 2,5 mm	Washer, red 2.5 mm
26-610-50-04	3	1	Distanzscheibe rot, 5,0 mm	Washer, red 5.0 mm
26-615-10-04	2	1	Kohlefaserstab 8 x 100 mm	Carbon fiber rod 8 x 100 mm
26-615-15-04	2	1	Kohlefaserstab 8 x 150 mm	Carbon fiber rod 8 x 150 mm
26-615-20-04	2	1	Kohlefaserstab 8 x 200 mm	Carbon fiber rod 8 x 200 mm
26-615-25-04	2	1	Kohlefaserstab 8 x 250 mm	Carbon fiber rod 8 x 250 mm
26-615-30-04	2	1	Kohlefaserstab 8 x 300 mm	Carbon fiber rod 8 x 300 mm
26-615-35-04	4	1	Kohlefaserstab 8 x 350 mm	Carbon fiber rod 8 x 350 mm
26-615-40-04	2	1	Kohlefaserstab 8 x 400 mm	Carbon fiber rod 8 x 400 mm
26-615-45-04	2	1	Kohlefaserstab 8 x 450 mm	Carbon fiber rod 8 x 450 mm
26-620-10-07	10	1	Inbusschraube 5 x 10 mm	Hex screw 5 x 10 mm
26-620-20-07	15	1	Inbusschraube 5 x 20 mm	Hex screw 5 x 20 mm
26-620-25-07	10	1	Inbusschraube 5 x 25 mm	Hex screw 5 x 25 mm
26-620-30-07	6	1	Inbusschraube 5 x 30 mm	Hex screw 5 x 30 mm
26-620-50-07	6	1	Inbusschraube 5 x 50 mm	Hex screw 5 x 50 mm
26-620-60-07	6	1	Inbusschraube 5 x 60 mm	Hex screw 5 x 60 mm
26-624-00-04	30	1	Schutzkappe	Safety cap
26-632-08-05	2	1	Schanz-Capretto-Schraube 80 mm	Schanz-Capretto screw 80 mm
26-632-12-05	2	1	Schanz-Capretto-Schraube 120 mm	Schanz-Capretto screw 120 mm



55-442-10-04
600 x 300 x 110 mm
MicroStop®-Container
MicroStop® container

25-500-10-04			Dynafix®-Set, komplett, bestehend aus:	Dynafix® Set, complete, consisting of:
Art.-Nr. Item No.	Stückzahl/Set Quantity/set	VE SU	Bezeichnung	Designation
26-632-15-05	6	1	Schanz-Capretto-Schraube 150 mm	Schanz-Capretto screw 150 mm
26-632-17-05	6	1	Schanz-Capretto-Schraube 170 mm	Schanz-Capretto screw 170 mm
26-632-20-05	4	1	Schanz-Capretto-Schraube 200 mm	Schanz-Capretto screw 200 mm
26-635-20-05	4	1	Steinmann-Nagel ohne Gewinde 200 mm	Steinmann pin without thread 200 mm
26-635-25-05	4	1	Steinmann-Nagel ohne Gewinde 250 mm	Steinmann pin without thread 250 mm
26-635-30-05	4	1	Steinmann-Nagel ohne Gewinde 300 mm	Steinmann pin without thread 300 mm
26-636-18-05	4	1	Steinmann-Nagel Mittelgewinde 180 mm	Steinmann pin with thread 180 mm
26-636-20-05	4	1	Steinmann-Nagel Mittelgewinde 200 mm	Steinmann pin with thread 200 mm
25-211-44-07	1	1	T-Handgriff AO	T-handle AO
26-570-15-07	1	1	Spiralbohrer, 3,5 x 145 mm	Twist drill 3.5 x 145 mm
26-570-20-07	1	1	Spiralbohrer, 3,5 x 195 mm	Twist drill 3,5 x 195 mm
26-572-15-07	1	1	Spiralbohrer, 4,5 x 145 mm	Twist drill 4,5 x 145 mm
26-572-20-07	1	1	Spiralbohrer, 4,5 x 195 mm	Twist drill 4,5 x 195 mm
26-638-00-07	1	1	Inbusschlüssel 5 mm	Hex wrench 5 mm
26-642-00-07	1	1	Handgriff für Gewebeschutzhülse	Handle for drill guides
26-642-07-07	1	1	Gewebeschutzhülse 70 mm	Drill guide 70 mm
26-642-10-07	1	1	Gewebeschutzhülse 100 mm	Drill guide 100 mm
26-643-07-07	1	1	Gewebeschutzhülse Ø 5,0 mm, 70 mm	Drill guide Ø 5.0 mm, 70 mm
26-643-10-07	1	1	Gewebeschutzhülse Ø 5,0 mm, 100 mm	Drill guide Ø 5.0 mm, 100 mm
26-646-00-04	2	1	Kompressions- und Distractionsgrundelement	Basic unit for compression and distraction
26-648-00-04	2	1	Oberteil zu 26-646-00	Upper part for 26-646-00
26-648-05-04	2	1	Oberteil zu 26-646-00, mit Kennzeichnung	Upper part for 26-646-00, with identification
26-655-50-07	1	1	Kardanschlüssel 5 mm	Cardan wrench 5 mm
26-660-05-07	1	1	Kombi-Instrument 5 mm	Combi-instrument 5 mm

25-500-10-04			Lagerung	Storage
Art.-Nr. Item No.	Stückzahl/Set Quantity/set	VE SU	Bezeichnung	Designation
55-442-10-04	1	1	MicroStop®-Container 600 x 300 x 110 mm	MicroStop® container 600 x 300 x 110 mm
55-443-12-04	2	1	Farbreiter, rot	Color tag, red
55-443-22-04	2	1	Codierschild mit Beschriftung, ohne Loch	Coding label, lettered, no hole
55-810-48-01	1	1	Dynafix®-Siebschale	Dynafix® tray

Dynafix®-Notfall-Set

Emergency Set

St

Edelstahl
Stainless steel

1

VE = Verpackungseinheit
SU = Quantity/pack

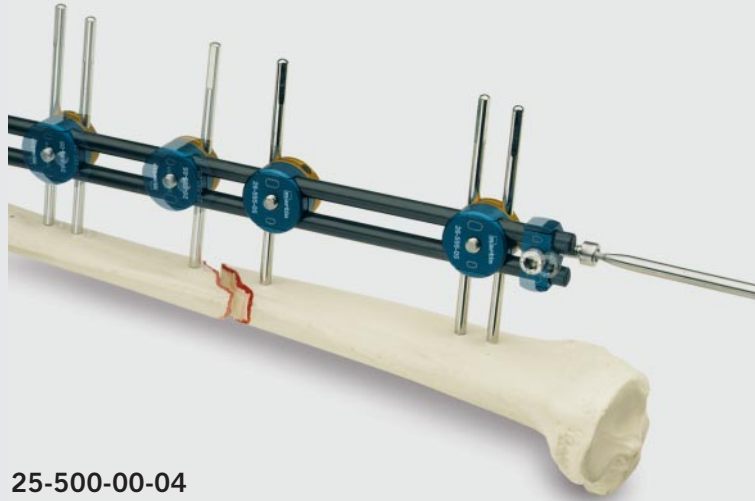

25-500-00-04
Dynafix®-Notfall-Set
Dynafix® Emergency Set

25-500-00-04			Dynafix®-Notfall-Set, komplett, bestehend aus:	Dynafix® Emergency Set complete, consisting of:
Art.-Nr. Item No.	Stückzahl/Set Quantity/set	VE SU	Bezeichnung	Designation
26-580-01-04	4	1	Montiertes Gelenk	Mounted joint
26-590-05-04	4	1	Gelenkoberteil, blau	Joint, upper part, blue
26-610-15-04	2	1	Distanzscheibe rot, 1,5 mm	Washer red, 1,5 mm
26-610-25-04	2	1	Distanzscheibe rot, 2,5 mm	Washer red, 2,5 mm
26-615-30-04	2	1	Kohlefaserstab 8 x 300 mm	Carbon-fiber rod 8 x 300 mm
26-632-15-05	4	1	Schanz-Capretto-Schraube 150 mm	Schanz-Capretto screw 150 mm
26-646-00-04	1	1	Kompressions- und Distraktionsgrundelement	Basic unit for compression and distraction
26-660-05-07	1	1	Kombi-Instrument 5 mm	Combi-instrument 5 mm



Zubehör
Accessories

159-169

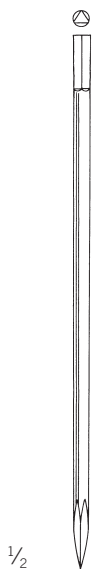

22-562-14-05 -
22-562-20-05

Steinmann-Nägel, mit Trokarspitze
Steinmann pins, with trocar tip
Ø 4 mm

Art.-Nr. Item No.	Länge Length
22-562-14-05	14 cm / 5 $\frac{1}{8}$ "
22-562-16-05	16 cm / 6 $\frac{3}{8}$ "
22-562-18-05	18 cm / 7 $\frac{1}{8}$ "
22-562-20-05	20 cm / 7 $\frac{3}{8}$ "



Böhler
22-565-15-07 -
22-565-21-07

Extensionsbügel
Wire traction bows

Art.-Nr. Item No.	Abmessungen Dimensions	Verwendung for use
22-565-15-07	210 x 150 mm 8" x 6"	für Oberschenkel und Knie for femur and knee
22-565-16-07	160 x 90 mm 6 $\frac{3}{8}$ " x 3 $\frac{1}{8}$ "	für Arm for arm
22-565-21-07	210 x 110 mm 8 $\frac{3}{8}$ " x 4 $\frac{3}{8}$ "	für Oberschenkel und Knie for femur and knee

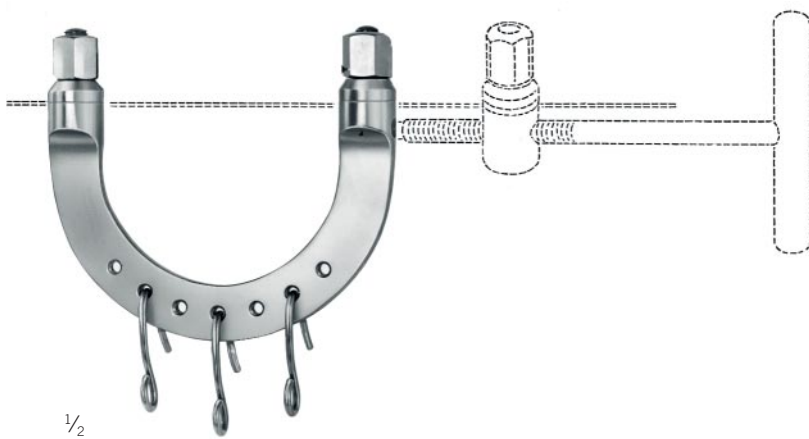

1/2

Kirschner
22-581-01-07 -
22-581-05-07

Extensionsbügel mit 3 Zughaken
Wire traction bows with 3 traction hooks



1/2

22-586-18-07

18,5 cm / 5 1/2"

Spannschlüssel
Wire strainer

➔ 22-581-01-07 - 22-581-05-07

Art.-Nr. Item No.	lichte Weite inner width	Verwendung for use
22-581-01-07	95 x 70 mm	für Kinder for children
22-581-02-07	105 x 105 mm	für Hand- und Fußgelenk for wrist and ankle
22-581-03-07	120 x 120 mm	für Ellenbogen for ellbow
22-581-04-07	155 x 155 mm	für Knie for knee
22-581-05-07	200 x 155 mm	für Oberschenkel for femur

Extensionsbügel-Sortiment

Wire Traction Bow Portfolio



1/2

Kirschner
22-585-01-07 -
22-585-02-07
mit 3 Zughaken
with 3 traction hooks



1/2

22-587-19-07
20 cm / 8"
Gabelschlüssel
Wrench



1/2

22-589-18-07 -
22-589-27-07

Art.-Nr. Item No.	Abmessungen Dimensions	
22-585-01-07	18,5 cm / 7 2/8"	kleines Modell small model
22-585-02-07	26,5 cm / 10 4/8"	großes Modell large model

Art.-Nr. Item No.	lichte Weite inner width
22-589-18-07	180 x 100 mm 7" x 4"
22-589-27-07	270 x 160 mm 10 4/8" x 6 2/8"



1/2

22-596-01-07 -
22-596-03-07

Drahtgeflecht, autoklavierbar
Wire mesh, autoclavable

22-601-90-98



1/2

22-601-02-07

Fixierscheiben
Fixation discs

für Bohrdrähte, Paar
for wire drills, pair



1/2

22-603-06-07

Zughaken für Extensionsbügel
Traction hook for extension bows

Zuggewicht bis 12 kg
Tensile load max. 12 kg

Art.-Nr. Item No.	
22-596-01-07	klein small
22-596-02-07	mittel medium
22-596-03-07	groß large

Bohrer

Drills

St

Edelstahl
Stainless steel

J

J-Kupplung
J-Notch

1

VE = Verpackungseinheit
SU = Quantity/pack



Ø	Spiralbohrer Twist drill	Spiralbohrer, kurz Twist drill, short	Flachbohrer Flat drill bit	Kugelfräser Spherical burr	Ovalfräser Oval burr	Spiralbohrer, kurz Twist drill, short
1,0 mm		22-192-10-07				22-199-10-07
1,2 mm		22-192-12-07				
1,5 mm		22-192-15-07				22-199-15-07
1,8 mm		22-192-18-07	22-194-18-07			
2,0 mm	22-190-20-07	22-192-20-07	22-194-20-07			22-199-20-07
2,2 mm		22-192-22-07	22-194-22-07			
2,5 mm	22-190-25-07	22-192-25-07	22-194-25-07			22-199-25-07
2,8 mm		22-192-28-07				22-199-28-07
3,0 mm	22-190-30-07	22-192-30-07	22-194-30-07	22-196-30-07	22-198-30-07	22-199-30-07
3,2 mm	22-190-32-07	22-192-32-07				22-199-32-07
3,5 mm	22-190-35-07	22-192-35-07	22-194-35-07			22-199-35-07
4,0 mm	22-190-40-07	22-192-40-07	22-194-40-07	22-196-40-07		22-199-40-07
4,5 mm						22-199-45-07
5,0 mm	22-190-50-07	22-192-50-07	22-194-50-07		22-198-50-07	22-199-50-07
6,0 mm	22-190-60-07					22-199-60-07
7,0 mm	22-190-70-07					



Ø	Doyen-Kugelfräser Doyen spherical burr		Konischer Fräser Conical burr		Zylindrischer Fräser Cylindrical burr		Spitzfräser Pointed burr		Flachfräser Flat trephine		Trephein mit Dorn Trephine with mandrel		
4,0 mm	22-210-04-07	22-212-04-07											
6,0 mm	22-210-06-07	22-212-06-07											
7,0 mm							22-225-07-07						
8,0 mm	22-210-08-07	22-212-08-07		22-218-08-07		22-224-08-07							
10,0 mm	22-210-10-07	22-212-10-07		22-218-10-07		22-224-10-07							
12,0 mm	22-210-12-07	22-212-12-07	22-216-12-07		22-220-12-07	22-224-12-07							
13,0 mm													
14,0 mm	22-210-14-07	22-212-14-07						22-226-13-07			22-228-08-07		
15,0 mm					22-220-15-07								
16,0 mm	22-210-16-07	22-212-16-07											
25,0 mm									22-227-25-07				

bis
up to
Ø 4 mm



22-606-01-07
Schlüssel
Wrench

Bunnel
22-606-00-07
mit Dreibackenspannfutter, längsdurchbohrt
with three jaw chuck, longitudinal bore

bis
up to
Ø 4 mm



Ralk
22-611-01-07
mit Leichtmetallgehäuse und Dreibackenfutter, kanüliert
with light metal housing and three jaw chuck, cannulated



22-620-99-07
Schlüssel
Wrench

22-620-05-07
Handgriff mit Dreibacken-Spannfutter,
mit Schlüssel
Handle with three jaw chuck,
with key



Fz
Ferrozell

2,5 mm	3,5 mm	3,5 mm	6 mm	6 mm	6 mm	6 mm	2,5 mm
22-368-24-07 21 cm / 8 3/8"	22-368-34-07 21 cm / 8 3/8"	22-368-35-07 25 cm / 9 7/8"	22-372-17-07 17 cm / 6 5/8"	Lane 22-374-25-07 25 cm / 9 7/8"	22-378-25-07 25 cm / 9 7/8"	Philips 22-380-25-07 25 cm / 9 7/8"	25-213-99-07 19,5 cm / 7 3/4"

25-213-90-98

1/2

Schraubendreher-Set

Screwdriver Set

Fz
Ferrozell



22-382-00-04
Schraubendreher-Set
Screwdriver set



1/2

22-382-02-07 Fz
14 cm / 5 1/8"
Schraubendreher, durchbohrt mit Schnellspannfutter
Screwdriver, with bore and quick-action chuck



bis Ø 6,3 mm
up to Ø 6.3 mm

1/1

22-382-13-07
7,5 cm / 3"
Jacobs-Bohrfutter
Jacobs (three-jaw chuck)



Ø 6 mm

1/2

22-382-03-07
14 cm / 5 1/8"
Schlitz-Ansatz
Flat-tip bit



Ø 6 mm

1/2

22-382-06-07
14 cm / 5 1/8"
Kreuzschlitz-Ansatz
Cross-tip bit

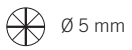

1/2

22-382-09-07
14 cm / 5 1/8"
Philips-Ansatz, groß
Philips-attachment, large size

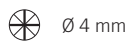

1/2

22-382-10-07
14 cm / 5 1/8"
Philips-Ansatz, klein
Philips-attachment, small



1/2

22-382-18-07
14 cm / 5 1/8"
Inbus-Schlüssel
Hexagonal wrench

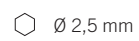

1/2

22-382-19-07
14 cm / 5 1/8"
Inbus-Schlüssel
Hexagonal wrench

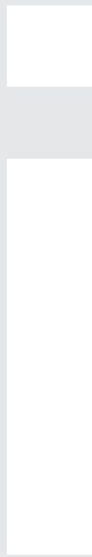

Nummern-Index
Index of order numbers

171-177

Nummern-Index

Index of order numbers

22

22-190-20-07	164
22-190-25-07	164
22-190-30-07	164
22-190-32-07	164
22-190-35-07	164
22-190-40-07	164
22-190-50-07	164
22-190-60-07	164
22-190-70-07	164
22-192-10-07	164
22-192-12-07	164
22-192-15-07	164
22-192-18-07	164
22-192-20-07	164
22-192-22-07	164
22-192-25-07	164
22-192-28-07	164
22-192-30-07	164
22-192-32-07	164
22-192-35-07	164
22-192-40-07	164
22-192-50-07	164
22-194-18-07	164
22-194-20-07	164
22-194-22-07	164
22-194-25-07	164
22-194-30-07	164
22-194-35-07	164
22-194-40-07	164
22-194-50-07	164
22-196-30-07	164
22-196-40-07	164
22-198-30-07	164
22-198-50-07	164
22-199-10-07	164
22-199-15-07	164
22-199-20-07	164
22-199-25-07	164
22-199-28-07	164
22-199-30-07	164
22-199-32-07	164
22-199-35-07	164
22-199-40-07	164
22-199-45-07	164
22-199-50-07	164
22-199-60-07	164
22-210-04-07	165
22-210-06-07	165
22-210-08-07	165
22-210-10-07	165
22-210-12-07	165
22-210-14-07	165
22-210-16-07	165
22-212-04-07	165
22-212-06-07	165
22-212-08-07	165
22-212-10-07	165
22-212-12-07	165
22-212-14-07	165

22-212-16-07	165
22-216-12-07	165
22-218-08-07	165
22-218-10-07	165
22-220-12-07	165
22-220-15-07	165
22-224-08-07	165
22-224-10-07	165
22-224-12-07	165
22-225-07-07	165
22-226-13-07	165
22-227-25-07	165
22-228-08-07	165
22-368-24-07	99, 100, 167
22-368-34-07	167
22-368-35-07	13, 22, 92, 167
22-372-17-07	167
22-374-25-07	167
22-378-25-07	167
22-380-25-07	167
22-382-00-04	168
22-382-02-07	168
22-382-03-07	168
22-382-06-07	168
22-382-09-07	169
22-382-10-07	169
22-382-13-07	168
22-382-18-07	169
22-382-19-07	169
22-500-20-07	74, 82
22-505-17-07	74, 82
22-507-18-07	74, 82
22-511-01-07	77
22-518-16-07	77
22-522-16-07	75, 82
22-523-16-07	77
22-523-22-07	75, 82
22-523-25-07	78
22-523-90-98	75
22-523-96-98	75
22-526-18-07	78
22-527-02-05	72
22-527-03-05	72
22-527-04-05	72
22-527-05-05	72
22-527-06-05	72
22-527-07-05	72
22-527-08-05	72
22-527-09-05	72
22-527-10-05	72, 82
22-527-12-05	72
22-527-15-05	72, 82
22-528-00-07	79
22-562-14-05	160
22-562-16-05	160
22-562-18-05	160
22-562-20-05	160
22-565-15-07	160

22-565-16-07	160
22-565-21-07	160
22-565-90-98	160
22-581-01-07	161
22-581-02-07	161
22-581-03-07	161
22-581-04-07	161
22-581-05-07	161
22-585-01-07	162
22-585-02-07	162
22-586-18-07	161
22-587-19-07	162
22-589-18-07	162
22-589-27-07	162
22-589-90-98	162
22-589-91-98	162
22-596-01-07	163
22-596-02-07	163
22-596-03-07	163
22-601-02-07	163
22-601-90-98	163
22-603-06-07	163
22-606-00-07	166
22-606-01-07	166
22-611-01-07	166
22-618-00-07	79
22-618-90-98	79
22-620-05-07	166
22-620-99-07	166
22-622-06-05	60, 72
22-622-08-05	60, 72
22-622-10-05	72
22-622-12-05	72
22-622-14-05	72
22-622-15-05	72
22-622-16-05	72
22-622-18-05	72
22-622-20-05	72
22-622-22-05	72
22-623-10-05	73
22-623-12-05	73
22-623-14-05	73
22-623-15-05	73
22-623-16-05	73
22-623-18-05	73
22-623-20-05	73
22-623-22-05	73
22-625-10-05	73
22-625-12-05	73
22-625-14-05	73
22-625-16-05	73
22-626-10-05	72
22-626-12-05	72
22-626-14-05	72
22-626-15-05	72
22-626-16-05	72
22-626-18-05	72
22-626-20-05	72
22-626-22-05	72
22-627-10-05	73

22-627-12-05	73
22-627-14-05	73
22-627-15-05	73
22-627-16-05	73
22-627-18-05	73
22-627-20-05	73
22-627-22-05	73
22-628-10-05	72
22-628-12-05	72
22-628-14-05	72
22-628-15-05	72
22-628-16-05	72
22-628-18-05	72
22-628-20-05	72
22-628-22-05	72
22-629-10-05	73
22-629-12-05	73
22-629-14-05	73
22-629-15-05	73
22-629-16-05	73
22-629-18-05	73
22-629-20-05	73
22-629-22-05	73
22-630-10-05	60, 72
22-630-12-05	60, 72, 82
22-630-14-05	72
22-630-15-05	72, 82
22-630-16-05	60, 72
22-630-18-05	72
22-630-20-05	72, 82
22-630-22-05	72
22-630-25-05	72, 82
22-631-10-05	73
22-631-12-05	73
22-631-14-05	73
22-631-15-05	73
22-631-16-05	73
22-631-18-05	73
22-631-20-05	73
22-631-22-05	73
22-631-25-05	73
22-632-10-05	72
22-632-12-05	72
22-632-14-05	72
22-632-15-05	72
22-632-16-05	72
22-632-18-05	72
22-632-20-05	72
22-632-22-05	72
22-632-25-05	72
22-633-10-05	73
22-633-12-05	73
22-633-14-05	73
22-633-15-05	73
22-633-16-05	73
22-633-18-05	73
22-633-20-05	73
22-633-22-05	73
22-633-25-05	73
22-634-10-05	73

22-634-12-05	73
22-634-15-05	73
22-634-16-05	73
22-634-18-05	73
22-634-20-05	73
22-634-22-05	73
22-634-25-05	73
22-636-06-05	73
22-636-08-05	73
22-636-10-05	73
22-636-12-05	73
22-636-14-05	73
22-636-15-05	73
22-636-16-05	73
22-636-18-05	73
22-636-20-05	73
22-636-25-05	73
22-637-06-05	73
22-637-08-05	73
22-637-10-05	73
22-637-12-05	73
22-637-14-05	73
22-637-15-05	73
22-637-16-05	73
22-637-18-05	73
22-637-20-05	73
22-637-25-05	73
22-638-08-05	73
22-638-10-05	73
22-638-12-05	73
22-638-14-05	73
22-638-15-05	73
22-638-16-05	73
22-638-18-05	73
22-638-20-05	73
22-638-25-05	73
22-639-10-05	73
22-639-12-05	73
22-639-14-05	73
22-639-15-05	73
22-639-16-05	73
22-639-18-05	73
22-639-20-05	73
22-639-25-05	73
22-640-40-05	73
22-640-42-05	73
22-640-44-05	73
22-640-45-05	73
22-640-46-05	73
22-640-48-05	73
22-640-50-05	73
22-640-55-05	73

23

23-433-03-07	60
23-433-18-07	32
23-435-18-07	50
23-539-06-07	32, 50, 60
23-539-08-07	32, 50, 60
23-539-15-07	32, 42

23-539-16-0750, 60
23-704-14-0733, 42,
.....51, 60
23-717-12-0751, 60
23-721-14-0733, 42,
.....51, 60
23-749-15-0733, 42
23-757-01-07130

25

25-100-01-0418
25-100-02-0420
25-100-03-0422
25-101-08-0546
25-101-10-0546
25-101-12-0546
25-101-14-0546
25-101-16-0546
25-101-18-0546
25-101-20-0546
25-101-22-0546
25-101-24-0546
25-101-26-0546
25-101-28-0546
25-101-30-0546
25-101-32-0546
25-101-34-0546
25-102-06-0546
25-102-08-0546, 58
25-102-10-0546, 58
25-102-12-0546, 58
25-102-14-0546, 58
25-102-16-0546, 58
25-102-18-0546, 58
25-102-20-0546, 58
25-102-22-0546, 58
25-102-24-0546, 58
25-102-26-0546
25-102-28-0546
25-102-30-0546
25-102-32-0546
25-102-34-0546
25-102-36-0546
25-102-38-0546
25-102-40-0546
25-103-10-0526
25-103-12-0526
25-103-14-0526
25-103-16-05...26, 95, 100
25-103-18-05...26, 95, 100
25-103-20-05...26, 95, 100
25-103-22-05...26, 95, 100
25-103-24-05...26, 95, 100
25-103-26-05...26, 95, 100
25-103-28-05...26, 95, 100
25-103-30-05...26, 95, 100
25-103-32-05...26, 95, 100
25-103-34-05...26, 95, 100
25-103-36-05...26, 95, 100
25-103-38-05...26, 95, 100

25-103-40-05...26, 95, 100
25-103-45-0526, 95
25-103-50-0526, 95
25-103-55-0526, 95
25-103-60-0526, 95
25-103-70-0526
25-104-08-0526
25-104-10-0526, 40
25-104-12-0526, 40
25-104-14-0526, 40
25-104-16-0526, 40
25-104-18-0526, 40
25-104-20-0526, 40
25-104-22-0526, 40
25-104-24-0526, 40
25-104-26-0526, 40
25-104-28-0526, 40
25-104-30-0526
25-104-32-0526, 40
25-104-34-0526
25-104-36-0526, 40
25-104-38-0526
25-104-40-0526, 40
25-104-45-0526
25-104-50-0526
25-104-55-0526
25-104-60-0526
25-104-65-0526
25-104-70-0526
25-104-75-0526
25-104-80-0526
25-104-85-0526
25-104-90-0526
25-104-95-0526
25-105-14-0526
25-105-16-0526
25-105-18-0526
25-105-20-0526
25-105-22-0526
25-105-24-0526
25-105-26-0526
25-105-28-0526
25-105-30-0526
25-105-32-0526
25-105-34-0526
25-105-36-0526
25-105-38-0526
25-105-40-0526
25-105-42-0526
25-105-44-0526
25-105-45-0526
25-105-50-0526
25-106-08-0526
25-106-10-0526
25-106-12-0526
25-106-14-0526, 40
25-106-16-0526, 40
25-106-18-0526, 40
25-106-20-0526, 40
25-106-22-0526, 40

25-106-24-0526, 40
25-106-26-0526, 40
25-106-28-0526, 40
25-106-30-0526
25-106-32-0526, 40
25-106-34-0526
25-106-36-0526, 40
25-106-38-0526
25-106-40-0526, 40
25-106-42-0526
25-106-44-0526
25-106-45-0526, 40
25-106-48-0526
25-106-50-0526, 40
25-106-55-0526, 40
25-106-60-0526, 40
25-106-65-0526
25-107-12-0528, 40
25-107-14-0528, 40
25-107-16-0528, 40
25-107-18-0528, 40
25-107-20-0528, 40
25-107-22-0528, 40
25-107-24-0528, 40
25-107-26-0528, 40
25-107-28-0528, 40
25-107-30-0528, 40
25-107-35-0528, 40
25-107-40-0528, 40
25-107-45-0528, 40
25-107-50-0528, 40
25-108-16-0528
25-108-18-0528
25-108-20-0528
25-108-22-0528
25-108-24-0528
25-108-26-0528
25-108-28-0528
25-108-30-0528
25-108-35-0528
25-108-40-0528
25-108-45-0528
25-108-50-0528
25-109-10-0528
25-109-12-0528
25-109-14-0528
25-109-16-0528
25-109-18-0528
25-109-20-0528
25-109-22-0528
25-109-24-0528
25-109-26-0528
25-109-28-0528
25-109-30-0528
25-109-35-0528
25-109-40-0528
25-109-45-0528
25-109-50-0528
25-109-55-0528
25-109-60-0528

25-110-00-0458, 60, 61
25-110-06-0546, 58
25-110-07-0546, 58
25-110-08-0546, 58
25-110-09-0546, 58
25-110-10-0546, 58
25-110-11-0546
25-110-12-0546, 58
25-110-14-0546, 58
25-110-16-0546, 58
25-110-18-0546
25-110-20-0546
25-111-06-0546, 58
25-111-08-0546, 58
25-111-10-0546, 58
25-111-12-0546, 58
25-111-14-0546, 58
25-111-16-0546, 58
25-111-18-0546, 58
25-111-20-0546, 58
25-111-22-0546
25-111-24-0546
25-111-26-0546
25-111-28-0546
25-111-30-0546
25-111-32-0546
25-111-34-0546
25-111-36-0546
25-111-38-0546
25-113-14-052
25-113-16-052
25-113-18-052
25-113-20-052
25-113-22-052
25-113-24-052
25-113-26-052
25-113-28-052
25-113-30-052
25-113-32-052
25-113-34-052
25-113-36-052
25-113-38-052
25-113-40-052
25-113-42-052
25-113-44-052
25-113-46-052
25-113-48-052
25-113-50-052
25-113-52-052
25-113-54-052
25-113-56-052
25-113-58-052
25-113-60-052
25-113-62-052
25-113-64-052
25-113-66-052
25-113-68-052
25-113-70-052
25-113-72-052
25-114-00-052

25-114-05-052
25-114-10-052
25-114-14-052, 18
25-114-16-052, 18
25-114-18-052, 18
25-114-20-052, 18
25-114-22-052, 18
25-114-24-052, 18
25-114-26-052, 18
25-114-28-052, 18
25-114-30-052, 18, 87
25-114-32-052, 18, 87
25-114-34-052, 18, 87
25-114-36-052, 18, 87
25-114-38-052, 18, 87
25-114-40-052, 18, 87
25-114-42-052, 18, 87
25-114-44-052, 18, 87
25-114-46-052, 18, 87
25-114-48-052, 18, 87
25-114-50-052, 18, 87
25-114-52-052, 18, 87
25-114-54-052
25-114-56-052, 18, 87
25-114-58-052
25-114-60-052, 18, 87
25-114-62-052
25-114-64-052, 18, 87
25-114-66-052
25-114-68-052
25-114-70-052, 18, 87
25-114-72-052
25-114-74-052
25-114-76-052
25-114-80-052
25-114-85-052
25-114-90-052
25-114-95-052
25-115-20-052
25-115-25-052, 18
25-115-30-052, 18
25-115-35-052, 18
25-115-40-052, 18
25-115-45-052, 18
25-115-50-052, 18
25-115-55-052, 18
25-115-60-052, 18
25-115-65-052, 18
25-115-70-052, 18
25-115-75-052
25-115-80-052
25-115-85-052
25-116-00-053, 18
25-116-05-053, 18
25-116-10-053, 18
25-116-15-053
25-116-20-053
25-116-30-053, 18
25-116-35-053, 18
25-116-40-053, 18

Nummern-Index

Index of order numbers

25-116-45-05.....	3, 18	25-119-60-05.....	28	25-125-18-05.....	5	25-134-28-05.....	105	25-138-45-05.....	108
25-116-50-05.....	3, 18	25-119-96-05.....	2, 19	25-126-06-05.....	6, 20	25-134-32-05.....	105	25-138-46-05.....	108
25-116-55-05.....	3, 18	25-119-98-05.....	28, 42,	25-126-07-05.....	6, 20	25-134-43-05.....	106	25-138-47-05.....	108
25-116-60-05.....	3, 18	46, 64	25-126-08-05.....	6, 20	25-134-45-05.....	106	25-138-48-05.....	108
25-116-65-05.....	3, 18	25-119-99-05.....	2, 19, 64	25-126-09-05.....	6, 20	25-134-47-05.....	106	25-138-49-05.....	108
25-116-70-05.....	3, 18	25-122-02-05.....	4	25-126-10-05.....	6, 20	25-134-53-05.....	106	25-138-60-05.....	108
25-116-75-05.....	3, 18	25-122-03-05.....	4	25-126-11-05.....	6	25-134-55-05.....	106	25-138-62-05.....	108
25-116-80-05.....	3, 18	25-122-04-05.....	4, 20	25-126-12-05.....	6, 20	25-134-57-05.....	106	25-138-64-05.....	108
25-116-85-05.....	3, 18	25-122-05-05.....	4, 20	25-126-13-05.....	6	25-134-62-05.....	105	25-138-66-05.....	108
25-116-90-05.....	3, 18	25-122-06-05.....	4, 20	25-126-14-05.....	6, 20	25-134-70-05.....	105	25-138-68-05.....	108
25-116-95-05.....	3, 18	25-122-07-05.....	4, 20	25-126-15-05.....	6	25-134-72-05.....	105	25-138-94-05.....	108
25-117-00-05.....	3	25-122-08-05.....	4	25-126-16-05.....	6	25-134-80-05.....	106	25-138-96-05.....	108
25-117-05-05.....	3	25-122-09-05.....	4	25-126-18-05.....	6	25-134-81-05.....	106	25-138-98-05.....	108
25-117-10-05.....	3	25-122-10-05.....	4	25-131-20-05.....	102	25-134-82-05.....	106	25-139-28-05.....	109
25-117-15-05.....	3	25-122-11-05.....	4	25-131-22-05.....	102	25-134-83-05.....	106	25-139-32-05.....	109
25-117-20-05.....	3	25-122-12-05.....	4	25-131-24-05.....	102	25-134-84-05.....	106	25-139-43-05.....	110
25-117-45-05.....	3, 18	25-123-02-05.....	4	25-131-26-05.....	102	25-134-85-05.....	106	25-139-45-05.....	110
25-117-50-05.....	3, 18	25-123-03-05.....	4	25-131-50-05.....	102	25-134-86-05.....	106	25-139-47-05.....	110
25-117-55-05.....	3, 18	25-123-04-05.....	4	25-131-52-05.....	102	25-134-87-05.....	106	25-139-53-05.....	110
25-117-60-05.....	3, 18	25-123-05-05.....	4	25-131-54-05.....	102	25-134-88-05.....	106	25-139-55-05.....	110
25-117-65-05.....	3, 18	25-123-06-05.....	4	25-131-56-05.....	102	25-134-89-05.....	106	25-139-57-05.....	110
25-117-70-05.....	3, 18	25-123-07-05.....	4	25-131-70-05.....	102	25-135-17-05.....	111, 117	25-139-62-05.....	109
25-117-75-05.....	3	25-123-08-05.....	4	25-131-72-05.....	102	25-135-19-05.....	111	25-139-70-05.....	109
25-117-80-05.....	3, 18	25-123-09-05.....	4	25-131-74-05.....	102	25-135-27-05.....	111	25-139-72-05.....	109
25-117-85-05.....	3	25-123-10-05.....	4	25-131-76-05.....	102	25-135-29-05.....	111	25-139-80-05.....	110
25-117-90-05.....	3, 18	25-123-11-05.....	4	25-131-90-05.....	102	25-135-37-05.....	111	25-139-81-05.....	110
25-117-95-05.....	3	25-123-12-05.....	4	25-131-92-05.....	102	25-135-39-05.....	111	25-139-82-05.....	110
25-118-00-05.....	3	25-123-13-05.....	4	25-131-94-05.....	102	25-135-60-05.....	112, 117	25-139-83-05.....	110
25-118-05-05.....	3	25-123-14-05.....	4	25-131-96-05.....	102	25-135-68-05.....	112	25-139-84-05.....	110
25-118-10-05.....	3	25-123-15-05.....	4	25-132-10-05.....	103	25-135-70-05.....	112	25-139-85-05.....	110
25-118-25-05.....	3, 18	25-123-16-05.....	4	25-132-11-05.....	103	25-135-78-05.....	112	25-139-86-05.....	110
25-118-30-05.....	3, 18	25-123-17-05.....	4	25-132-12-05.....	103	25-136-25-05.....	113, 117	25-139-87-05.....	110
25-118-35-05.....	3, 18	25-123-18-05.....	4	25-132-14-05.....	103	25-136-26-05.....	113	25-139-88-05.....	110
25-118-40-05.....	3, 18	25-124-02-05.....	5	25-132-15-05.....	103	25-136-35-05.....	113	25-139-89-05.....	110
25-118-45-05.....	3	25-124-03-05.....	5	25-132-16-05.....	103	25-136-36-05.....	113	25-140-05-05.....	7, 20
25-118-50-05.....	3	25-124-04-05.....	5, 20	25-132-17-05.....	103	25-137-20-05.....	107	25-140-06-05.....	7, 20
25-118-55-05.....	3	25-124-05-05.....	5, 20	25-132-18-05.....	103	25-137-22-05.....	107	25-140-13-05.....	7
25-118-60-05.....	3	25-124-06-05.....	5, 20	25-132-19-05.....	103	25-137-24-05.....	107	25-140-14-05.....	7, 20
25-118-70-05.....	3	25-124-07-05.....	5, 20	25-133-24-05.....	104	25-137-26-05.....	107	25-140-15-05.....	7
25-118-75-05.....	3	25-124-08-05.....	5, 20	25-133-26-05.....	104	25-137-50-05.....	107	25-140-16-05.....	7, 20
25-118-80-05.....	3	25-124-09-05.....	5, 20	25-133-28-05.....	104	25-137-52-05.....	107	25-140-18-05.....	7, 20
25-118-85-05.....	3	25-124-10-05.....	5, 20	25-133-36-05.....	104	25-137-54-05.....	107	25-140-23-05.....	29, 41
25-118-90-05.....	3	25-124-11-05.....	5	25-133-38-05.....	104	25-137-56-05.....	107	25-140-24-05.....	29, 41
25-118-95-05.....	3	25-124-12-05.....	5, 20	25-133-40-05.....	104	25-137-70-05.....	107	25-140-34-05.....	8, 20
25-119-10-05.....	28	25-124-13-05.....	5	25-133-41-05.....	104	25-137-72-05.....	107	25-140-35-05.....	8
25-119-12-05.....	28	25-124-14-05.....	5	25-133-42-05.....	104	25-137-74-05.....	107	25-140-36-05.....	8
25-119-14-05.....	28	25-124-15-05.....	5	25-133-44-05.....	104	25-137-76-05.....	107	25-140-44-05.....	8, 20
25-119-16-05.....	28	25-124-16-05.....	5	25-133-45-05.....	104	25-137-90-05.....	107	25-140-46-05.....	9
25-119-18-05.....	28	25-124-18-05.....	5	25-133-46-05.....	104	25-137-92-05.....	107	25-140-47-05.....	9
25-119-20-05.....	28	25-125-06-05.....	5	25-133-47-05.....	104	25-137-94-05.....	107	25-140-48-05.....	9
25-119-22-05.....	28	25-125-07-05.....	5	25-133-48-05.....	104	25-137-96-05.....	107	25-140-49-05.....	9
25-119-24-05.....	28	25-125-08-05.....	5	25-133-49-05.....	104	25-138-24-05.....	108	25-140-50-05.....	9
25-119-26-05.....	28	25-125-09-05.....	5	25-133-60-05.....	104	25-138-26-05.....	108	25-140-54-05.....	8, 20
25-119-28-05.....	28	25-125-10-05.....	5	25-133-62-05.....	104	25-138-28-05.....	108	25-140-56-05.....	9
25-119-30-05.....	28	25-125-11-05.....	5	25-133-64-05.....	104	25-138-36-05.....	108	25-140-57-05.....	9
25-119-35-05.....	28	25-125-12-05.....	5	25-133-66-05.....	104	25-138-38-05.....	108	25-140-58-05.....	9
25-119-40-05.....	28	25-125-13-05.....	5	25-133-68-05.....	104	25-138-40-05.....	108	25-140-59-05.....	9
25-119-45-05.....	28	25-125-14-05.....	5	25-133-94-05.....	104	25-138-41-05.....	108	25-140-60-05.....	9
25-119-50-05.....	28	25-125-15-05.....	5	25-133-96-05.....	104	25-138-42-05.....	108	25-140-90-05.....	9
25-119-55-05.....	28	25-125-16-05.....	5	25-133-98-05.....	104	25-138-44-05.....	108	25-140-91-05.....	9

25-140-98-05.....9	25-170-40-05.....95	25-210-15-07.....52, 60	25-221-04-01.....14, 22	25-238-01-07.....90, 99
25-140-99-05.....9	25-170-45-05.....95	25-210-19-07.....34, 42,	25-221-10-07.....14, 22	25-238-05-07.....88, 92
25-141-02-05.....29, 41	25-170-50-05.....9552, 60	25-221-12-07.....14, 22	25-238-06-07.....89, 92
25-141-03-05.....29, 41	25-170-55-05.....95	25-210-25-07.....34, 42,	25-221-15-07.....15, 22	25-238-08-07.....90, 92,
25-141-04-05.....29, 41	25-170-60-05.....9596, 100	25-221-17-07.....15, 2299, 100
25-141-05-05.....29, 41	25-170-65-05.....95	25-210-26-07.....52, 60	25-222-21-01.....56, 61	25-238-12-07.....88
25-141-06-05.....29, 41	25-170-70-05.....95	25-210-30-07.....10, 91, 96	25-222-32-01.....36, 42,	25-238-13-07.....88, 92
25-141-07-05.....29, 41	25-170-75-05.....95	25-210-31-07.....10, 2296, 100	25-238-14-07.....90, 92
25-141-08-05.....29, 41	25-170-80-05.....95	25-210-35-07.....34, 42	25-222-43-01.....114, 120	25-238-17-07.....88, 92
25-141-09-05.....29	25-170-85-05.....95	25-210-44-07.....10, 22, 91	25-222-44-01.....15, 22, 91	25-238-18-04.....88, 92
25-141-10-05.....29	25-170-90-05.....95	25-210-88-07.....53, 60	25-228-00-05.....97, 100	25-238-19-04.....88
25-141-12-05.....29	25-170-99-05.....95	25-210-89-07.....34, 42,	25-228-05-07.....97, 100	25-238-20-07.....89, 92
25-141-13-05.....30, 41	25-178-03-05.....9452, 60, 141, 148	25-228-06-07.....97, 100	25-238-21-07.....88, 89, 92
25-141-14-05.....30, 41	25-178-04-05.....94	25-210-95-07.....53, 60	25-228-12-07.....98, 100	25-238-25-04.....90
25-141-15-05.....30	25-178-06-05.....94	25-210-96-07.....10, 22	25-228-14-07.....98, 100	25-291-45-01.....76, 82
25-141-16-05 30	25-178-08-05.....94	25-210-99-07.....10, 22	25-228-17-07.....98, 100	25-291-70-01.....76, 82
25-141-23-05.....30, 41	25-179-03-05.....94	25-211-15-07.....53, 60	25-228-20-07.....97, 100	25-298-99-07.....57, 61
25-141-25-05.....30, 41	25-179-04-05.....94	25-211-19-07.....53, 60	25-228-21-07.....97, 100	25-300-00-04.....120, 121
25-142-13-05.....47, 59	25-179-06-05.....94	25-211-26-07.....52, 60	25-228-25-04.....98	25-400-00-04.....92, 93
25-142-14-05.....47, 59	25-179-08-05.....94	25-211-32-07.....34, 42	25-229-01-07.....56, 61	25-406-99-07.....144
25-142-15-05.....47, 59	25-180-00-05.....87, 92	25-211-34-07.....34, 42	25-229-02-07.....17, 22	25-410-00-07.....144
25-142-16-05.....47, 59	25-180-05-05.....87	25-211-43-07.....35, 42,	25-229-04-07.....37, 42	25-500-00-04.....158
25-142-17-05.....47, 59	25-180-10-05.....87, 9253, 60, 141, 148	25-229-05-07.....37, 42	25-500-10-04.....156, 157
25-142-18-05.....47, 59	25-180-15-05.....87	25-211-44-07.....11, 22,	25-229-10-07.....56, 61	25-600-00-04.....68, 69
25-142-19-05.....47	25-180-20-05.....87154, 157	25-229-15-07.....38, 42,	25-607-10-05.....64, 68
25-142-21-05.....47	25-180-50-05.....87	25-211-45-07.....11, 2257, 61	25-607-12-05.....64, 68
25-142-31-05.....48	25-180-55-05.....87	25-211-46-07.....11, 22	25-229-20-07.....16	25-607-14-05.....64, 68
25-142-32-05.....48	25-180-60-05.....87, 92	25-211-48-07.....11	25-229-29-07.....57, 61	25-607-16-05.....64, 68
25-142-33-05.....48, 59	25-180-65-05.....87	25-211-66-07.....11, 22	25-229-30-07.....17, 22	25-607-18-05.....64, 68
25-142-34-05.....48, 59	25-180-70-05.....87, 92	25-212-15-01.....54, 60	25-229-45-01.....16, 22	25-607-20-05.....64, 68
25-142-41-05.....48	25-180-75-05.....87	25-212-20-01.....35, 42,	25-229-47-01.....16, 22	25-607-22-05.....64, 68
25-143-13-05.....48, 59	25-180-80-05.....87, 9254, 60	25-229-49-01.....16, 22	25-607-24-05.....64, 68
25-143-14-05.....48, 59	25-180-85-05.....87, 92	25-212-26-01.....12, 22,	25-229-55-01.....38, 42	25-607-26-05.....64, 68
25-143-15-05.....48, 59	25-180-90-05.....87, 9254, 60	25-229-57-01.....38, 42	25-607-28-05.....64, 68
25-143-16-05.....48	25-180-95-05.....87, 92	25-212-27-01.....35, 42	25-229-90-98.....38, 57	25-607-30-05.....64, 68
25-143-31-05.....49	25-180-99-05.....87, 92	25-212-32-01.....12, 22	25-232-01-01.....114, 120	25-615-25-05.....64, 68
25-143-32-05.....49	25-181-01-05.....86	25-212-44-01.....35, 42	25-232-04-01.....114, 120	25-615-30-05.....64, 68
25-143-33-05.....49, 59	25-181-02-05.....86, 92	25-212-45-01.....12, 22, 90	25-232-05-07.....115, 120	25-615-35-05.....64, 68
25-143-34-05.....49, 59	25-181-04-05.....86, 92	25-212-47-01.....12, 22	25-232-06-07.....115, 120	25-615-40-05.....64, 68
25-143-41-05.....49, 59	25-181-05-05.....86, 92	25-212-90-98.....12	25-232-09-07.....115, 120	25-615-45-05.....64, 68
25-144-02-05.....49	25-181-06-05.....86, 92	25-213-90-98.....167	25-232-12-07.....116, 120	25-615-50-05.....64, 68
25-144-04-05.....49	25-181-08-05.....86	25-213-99-07.....167	25-232-13-07.....116, 120	25-615-55-05.....64, 68
25-144-05-05.....49	25-181-10-05.....86	25-214-02-07.....36, 42	25-232-14-07.....116, 120	25-616-00-05.....65, 68
25-144-06-05.....49	25-181-12-05.....86	25-214-03-07.....36, 42,	25-232-15-07.....117, 120	25-616-05-05.....65, 68
25-144-07-05.....49	25-181-14-05.....8653, 60	25-232-17-07.....116, 120	25-616-10-05.....65, 68
25-144-08-05.....49	25-181-16-05.....86	25-214-15-07.....13, 22	25-232-20-07.....117, 120	25-616-15-05.....65, 68
25-144-09-05.....49	25-181-18-05.....86	25-214-21-07.....13, 22	25-232-21-07.....117, 120	25-616-20-05.....65, 68
25-144-10-05.....49	25-182-04-05.....86	25-214-32-07.....53, 60	25-232-30-07.....117, 120	25-616-25-05.....65, 68
25-144-12-05.....49	25-182-06-05.....86	25-219-03-07.....54, 61	25-232-31-07.....117, 120	25-616-30-05.....65, 68
25-148-02-05.....31	25-182-08-05.....86	25-219-04-07.....36, 42,	25-232-32-07.....117, 120	25-616-35-05.....65, 68
25-148-03-05.....31	25-183-02-05.....8655, 61, 96, 100	25-233-01-01.....118, 120	25-616-40-05.....65, 68
25-148-04-05.....31	25-183-04-05.....86	25-219-05-07.....13, 22, 91	25-233-02-01.....118, 120	25-616-45-05.....65, 68
25-148-05-05.....31	25-183-06-05.....86	25-219-39-07.....13, 22,	25-233-03-01.....118, 120	25-616-50-05.....65, 68
25-148-06-05.....31, 41	25-183-08-05.....8637, 42, 55, 61	25-233-06-01.....119, 120	25-616-55-05.....65, 68
25-148-07-05.....31	25-183-10-05.....86	25-219-41-01.....55, 61	25-233-07-01.....119, 120	25-616-60-05.....65, 68
25-148-08-05.....31, 41	25-183-12-05.....86	25-219-42-01.....55, 61	25-233-08-01.....119, 120	25-616-65-05.....65, 68
25-148-10-05.....31, 41	25-183-14-05.....86	25-219-43-01.....37, 42	25-233-10-01.....118, 120	25-616-70-05.....65, 68
25-148-12-05.....31	25-183-16-05.....86	25-219-97-07.....2, 19,	25-233-16-01.....119, 120	25-616-75-05.....65, 68
25-170-00-04.....100	25-200-00-04.....82, 8337, 42, 55, 61	25-233-20-01.....118, 120	25-616-80-05.....65, 68
25-170-35-05.....95	25-210-11-07.....52, 60	25-221-01-01.....14, 22	25-238-00-05.....88, 92	25-616-85-05.....65, 68

Nummern-Index

Index of order numbers

25-616-90-05.....65, 68	26-103-40-0927	26-502-46-09.....124, 133	26-620-50-07152, 156136, 146
25-616-95-05.....65, 68	26-103-42-0927	26-502-48-09.....124, 133	26-620-60-07152, 156	26-901-34-09124, 133,
25-617-00-05.....65, 68	26-103-44-0927	26-502-50-09.....124, 133	26-624-00-04.....153, 156136, 146
25-617-05-05.....65, 68	26-105-10-0927	26-504-12-09.....124, 133	26-630-08-05.....153	26-901-36-09124, 133,
25-617-10-05.....65, 68	26-105-11-0927	26-504-14-09.....124, 133	26-630-12-05.....153136, 146
25-617-15-05.....65, 68	26-105-12-0927	26-504-16-09.....124, 133	26-630-15-05.....153	26-901-38-09124, 133,
25-617-20-05.....65, 68	26-105-13-0927	26-504-18-09.....124, 133	26-630-17-05.....153136, 146
25-617-35-05.....65, 68	26-105-14-0927	26-504-20-09.....124, 133	26-630-20-05.....153	26-901-40-09124, 133,
25-617-40-05.....65, 68	26-105-15-0927	26-504-22-09.....124, 133	26-632-08-05.....153, 156136, 146
25-617-45-05.....65, 68	26-105-16-0927	26-504-24-09.....124, 133	26-632-12-05.....153, 156	26-901-42-09124, 133,
25-617-50-05.....65, 68	26-105-17-0927	26-504-26-09.....124, 133	26-632-15-05.....153,136, 146
25-617-55-05.....65, 68	26-105-18-0927	26-504-28-09.....124, 133157, 158	26-901-44-09124, 133,
25-617-60-05.....65, 68	26-105-19-0927	26-504-30-09.....124, 133	26-632-17-05.....153, 157136, 146
25-617-65-05.....65, 68	26-105-20-0927	26-504-32-09.....124, 133	26-632-20-05.....153, 157	26-901-46-09124, 133,
25-617-70-05.....65, 68	26-105-22-0927	26-504-34-09.....124, 133	26-635-20-05.....153, 157136, 146
25-617-75-05.....65, 68	26-105-24-0927	26-504-36-09.....124, 133	26-635-25-05.....153, 157	26-901-48-09124, 133,
25-617-80-05.....65, 68	26-105-26-0927	26-504-38-09.....124, 133	26-635-30-05.....153, 157136, 146
25-617-85-05.....65, 68	26-105-28-0927	26-504-40-09.....124, 133	26-636-18-05.....153, 157	26-901-50-09124,
25-617-90-05.....65, 68	26-105-30-0927	26-504-42-09.....124, 133	26-636-20-05.....153, 157133, 136
25-617-95-05.....65, 68	26-105-32-0927	26-504-44-09.....124, 133	26-638-00-07155, 157	26-901-52-09124
25-620-13-05.....65, 69	26-105-34-0927	26-504-46-09.....124, 133	26-642-00-07154, 157	26-901-54-09124
25-620-16-05.....65, 69	26-105-36-0927	26-504-48-09.....124, 133	26-642-07-07154, 157	26-901-56-09124
25-620-19-05.....65, 69	26-105-38-0927	26-504-50-09.....124, 133	26-642-10-07154, 157	26-901-58-09124
25-622-10-05.....66, 69	26-105-40-0927	26-570-15-07154, 157	26-643-07-07154, 157	26-901-60-09124
25-622-15-05.....66, 69	26-105-42-0927	26-570-20-07154, 157	26-643-10-07154, 157	26-901-62-09124
25-622-20-05.....66, 69	26-105-44-0927	26-572-15-07157	26-646-00-04152,	26-901-64-09124
25-624-10-05.....66, 69	26-142-00-07130, 142,	26-572-20-07154, 157157, 158	26-901-66-09124
25-624-15-05.....66, 69148	26-580-01-04150,	26-648-00-04152, 157	26-901-68-09124
25-626-00-07.....66, 69	26-180-00-04132156, 158	26-648-05-04152, 157	26-901-70-09124
25-626-05-07.....66, 69	26-184-10-09125, 132	26-585-05-04150, 156	26-655-50-07155, 157	26-903-00-09136, 147
25-626-10-07.....67, 69	26-184-11-09125, 132	26-585-10-04150, 156	26-660-05-07155,	26-903-08-09124,
25-626-15-07.....67, 69	26-185-10-07130	26-585-15-04150, 156157, 158136, 147
25-626-20-07.....67, 69	26-185-20-07126, 132	26-590-05-04151,	26-900-00-04146,	26-903-10-09124,
25-628-00-07.....66, 69	26-185-27-07126, 132156, 158147, 148136, 147
25-628-03-07.....67, 69	26-185-35-07126, 132	26-590-10-04151, 156	26-901-00-09136, 146	26-903-12-09124, 133,
25-628-10-07.....67, 69	26-186-10-09125, 132	26-595-05-04151, 156	26-901-08-09124,136, 147
25-630-05-07.....67, 69	26-186-11-09125, 132	26-600-05-04151, 156136, 146	26-903-14-09124, 133,
	26-187-10-09125, 132	26-600-10-04151, 156	26-901-10-09124,136, 147
	26-187-11-09125, 132	26-605-05-04151, 156136, 146	26-903-16-09124, 133,
	26-188-10-09125, 132	26-605-10-04150, 156	26-901-12-09124, 133,136, 147
	26-188-11-09125, 132	26-605-20-04151, 156136, 146	26-903-18-09124, 133,
	26-190-01-09125, 132	26-610-00-04152, 156	26-901-14-09124, 133,136, 147
	26-453-17-07129	26-610-15-04152,136, 146	26-903-20-09124, 133,
	26-502-12-09124, 133156, 158	26-901-16-09124, 133,136, 147
	26-502-14-09124, 133	26-610-25-04152,136, 146	26-903-22-09124, 133,
	26-502-16-09124, 133156, 158	26-901-18-09124, 133,136, 147
	26-502-18-09124, 133	26-610-50-04152, 156136, 146	26-903-24-09124, 133,
	26-502-20-09124, 133153, 156	26-901-20-09124, 133,136, 147
	26-502-22-09124, 133	26-615-10-04153, 156136, 146	26-903-26-09124, 133,
	26-502-24-09124, 133	26-615-15-04153, 156	26-901-22-09124, 133,136, 147
	26-502-26-09124, 133	26-615-20-04153, 156136, 146	26-903-28-09124, 133,
	26-502-28-09124, 133	26-615-25-04153, 156	26-901-24-09124, 133,136, 147
	26-502-30-09124, 133	26-615-30-04153,136, 146	26-903-30-09124, 133,
	26-502-32-09124, 133156, 158	26-901-26-09124, 133,136, 147
	26-502-34-09124, 133	26-615-35-04153, 156136, 146	26-903-32-0124, 133,
	26-502-36-09124, 133	26-615-40-04153, 156	26-901-28-09124, 133,136, 147
	26-502-38-09124, 133	26-620-10-07152, 156136, 146	26-903-34-09124, 133,
	26-502-40-09124, 133	26-620-20-07152, 156	26-901-30-09124, 133,136, 147
	26-502-42-09124, 133	26-620-25-07152, 156136, 146	26-903-36-09124, 133,
	26-502-44-09124, 133	26-620-30-07152, 156	26-901-32-09124, 133,136, 147

26

26-903-38-09124, 133,
.....136, 147
26-903-40-09124, 133,
.....136, 147
26-903-42-09124,
.....133, 136
26-903-44-09124,
.....133, 136
26-903-46-09124,
.....133, 136
26-903-48-09124,
.....133, 136
26-903-50-09124,
.....133, 136
26-903-52-09124
26-903-54-09124
26-903-56-09124
26-903-58-09124
26-903-60-09124
26-903-62-09124
26-903-64-09124
26-903-66-09124
26-903-68-09124
26-903-70-09124
26-910-06-09137, 146
26-910-08-09137, 146
26-910-10-09138, 146
26-910-11-09138, 146
26-910-12-09138, 146
26-910-13-09138, 146
26-910-20-09137, 146
26-910-30-09137, 146
26-910-32-09137
26-910-40-09137, 146
26-910-41-09137, 146
26-910-50-09137, 146
26-910-51-09137, 146
26-920-06-09138, 147
26-920-08-09138, 147
26-920-20-09138, 147
26-920-21-09138, 147
26-920-22-09138, 147
26-920-50-09139, 147
26-920-51-09139, 147
26-920-60-09139, 147
26-920-61-09139, 147
26-920-80-09139, 147
26-920-81-09139, 147
26-920-90-09139, 147
26-920-91-09139, 147
26-930-10-07143
26-930-11-07143
26-930-20-07148
26-930-21-07141, 148
26-930-23-07145
26-930-24-07145
26-931-27-07126, 132,
.....142, 148
26-931-35-07126, 132,
.....142, 148

26-933-27-07130,
.....142, 148
26-933-35-07130,
.....142, 148
26-934-27-07130,
.....142, 148
26-934-35-07130,
.....142, 148
26-935-27-07131,
.....142, 148
26-935-35-07131,
.....142, 148
26-937-20-07127, 132,
.....140, 148
26-937-21-07131
26-937-25-07127, 132,
.....140, 148
26-937-27-07127, 132,
.....140, 148
26-937-35-07127, 132,
.....140, 148
26-938-27-07128, 132,
.....141, 148
26-938-35-07128, 132,
.....141, 148
26-945-00-07128
26-945-60-07132,
.....143, 148
26-945-70-07131
26-948-00-07144
26-950-11-07132
26-950-17-07129,
.....143, 148
26-952-00-07132

43

43-031-03-07143, 148

47

47-606-13-0776, 82
47-608-13-0776

50

50-124-16-07144

55

55-337-02-0161
55-440-15-0419, 21,
.....43, 61
55-440-20-0469
55-442-10-0423, 83,
.....121, 157
55-442-13-0493
55-443-12-0419, 21, 23,
.....43, 61, 69, 83,
.....93, 121, 157
55-443-22-0419, 21, 23,
.....43, 61, 69, 83,
.....93, 121, 157
55-550-50-01100

55-550-60-0193
55-555-61-0493
55-730-00-0180
55-730-16-0180
55-730-31-0180
55-730-90-9880
55-731-16-0180
55-731-31-0180
55-732-08-0181
55-732-10-0181
55-732-12-0181, 82
55-732-14-0181
55-732-15-0181, 82
55-732-16-0181
55-732-18-0181
55-732-20-0181, 82
55-732-22-0181
55-732-25-0181, 82
55-732-90-9881
55-734-08-0181
55-734-10-0181
55-734-12-0181
55-734-14-0181
55-734-15-0181
55-734-16-0181
55-734-18-0181
55-734-20-0181
55-734-22-0181
55-734-25-0181
55-805-24-0121
55-805-25-0121, 43, 61
55-805-48-0183
55-805-49-0123, 121
55-806-02-0423, 43, 61
55-806-51-0423, 43, 61
55-807-48-04121
55-810-48-01157
55-900-05-04148
55-900-06-04148
55-900-07-04148
55-900-08-04148
55-900-10-04148
55-980-05-04132
55-980-10-04132
55-980-74-07132
55-996-55-0419, 21,
.....43, 61
55-996-56-0483, 121
55-996-57-0423

56

56-520-00-0119
56-535-00-0428, 43, 46
56-540-00-0169
56-540-00-0461

90

90-651-51-2191

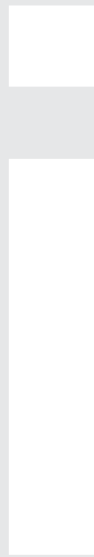

Index, alphabetisch
Deutsch

Index, alphabetical
English

179-183

A			
Akromion-Klavikula-Platte (AC).....	125		
Ausschlaginstrument	117		
B			
BC Platte.....	125		
Biegepresse	17		
Biegeschablonen.....	16, 38		
Biegezangen	16, 38, 56, 57, 76, 144		
Bi-kortikale Humerusplatte.....	125		
Böhler Extensionsbügel.....	160		
Bohrbüchsen für Handgrff.....	130, 142		
Bohrdrahtspender.....	80, 81		
Bohrer.....	164		
Bohrführung Ø 2,7 mm.....	126, 142		
Bohrführung Ø 3,5 mm.....	126, 142		
Bohrlehre für Plattenspanner.....	14		
Bohrlehre für Rund- und Halbrohrplatten.....	14		
Bohrlehre neutral/exzentrisch Ø 2 mm.....	56		
Bohrlehre neutral/exzentrisch Ø 2,5 mm.....	36, 96		
Bohrlehre neutral/exzentrisch Ø 3,2 mm.....	15, 91		
Bohrlehre Ø 1,1/1,5 mm.....	54		
C			
CC Platten	125		
Cerclage-System	71-83		
D			
Dental-Handstück	53		
Distractionselement, Fixateur	152		
DMS-Platten	86		
DMS	85-100		
DMS Führungsdraht Ø 2,5 mm.....	88		
DMS Intermediate Röntgenschablone.....	99		
DMS Intermediate Tragschraubendreherhülse.....	97		
DMS Intermediate-Dreistufenbohrer.....	98		
DMS Intermediate-Führungsdraht Ø 2,0 mm.....	97		
DMS Intermediate-Gewindeschneider.....	98		
DMS Intermediate-Kompressionsschraube.....	95		
DMS Intermediate-Messhülse.....	97		
DMS Intermediate-Platten.....	94		
DMS Intermediate-Platten-Einschläger.....	98		
DMS Intermediate-Set	100		
DMS Intermediate-Tragschrauben.....	95		
DMS Intermediate-Verbindungsanker.....	97		
DMS Intermediate-Zusatzhülse.....	97		
DMS-Dreistufenbohrer	88		
DMS-Gewindeschneider	88		
DMS-Kompressionsschrauben.....	87		
DMS-Messhülse	88		
DMS-Platten	86		
DMS-Platten-Einschläger	90		
DMS-Röntgenschablone	91		
DMS-Schraubendreher.....	89		
DMS-T-Handgriff	99		
DMS-Tragschrauben.....	87		
DMS-Verbindungsanker.....	89		
DMS-Zentrierhülse	88		
DMS-Zielgerät	90		
DMS-Zusatzhülse für Schraubendreher.....	89		
Doyen Kugelfräser	165		
Drahtbiegezange	76		
Draht-Cerclage-System	71-83		
Draht-Führung	67		
Drahtgeflecht, autoklavierbar.....	163		
Drahtschneider.....	78		
Drahtumführungsinstrumente	76		
Drahtzwirbelzange	74		
Dreistufenbohrer, DMS.....	88		
Dreistufenbohrer, DMS Intermediate	98		
Drittelrohrplatten.....	29		
Durchbohrte Schrauben	63		
Dynafix Kombiinstrument Ø 5 mm.....	155		
Dynafix®	149-158		
Dynafix®-Sets.....	156, 158		
E			
EasyCut.....	78		
Ein- und Ausschlaginstrument	117		
Eindreh Schlüssel für Hohlschrauben	67		
Einschlaginstrument.....	117		
Einsteckbohrbüchsen.....	130, 142		
Einzel-Bohrdrahtspender	81		
Explantation-Schraubendreher.....	129		
Extensionsbügel Böhler.....	160		
Extensionsbügel Kirschner	161, 162		
Extensionsbügel-Sortiment	160-163		
Externer Fixateur.....	149-158		
Extraktionszange	77		
F			
Flachbohrer	164		
Flachfräser	165		
Flachzange	74, 77		
FOS Vor- und Rückfuß-System.....	135-148		
FOS-Biegeinstrumente.....	143, 145		
FOS-Multifunktionszange	145		
FOS-Platten	137		
Fräser	164, 165		
Führungsdraht Ø 2,0 mm.....	97		
Führungsdraht Ø 2,5 mm.....	88		
Führungsplatte für Winkelplatten- Sitzinstrumente.....	115		
Führungsspieße für Hohlschrauben	66		
G			
Gabelschlüssel.....	162		
Gabelschlüssel 11 mm	15		
Gelenkteile, Fixateur.....	150, 151		
Gewebeschutzhülse f. Bohrer Ø 3,5 mm.....	12, 54		
Gewebeschutzhülse Ø 2,7 mm	126, 142		
Gewebeschutzhülse Ø 3,5 mm	126, 142		
Gewebeschutzhülse Ø 4,5 mm	12, 90		
Gewebeschutzhülse Ø 2,5/3,5 mm.....	35		
Gewebeschutzhülse Winkelplatten	114		
Gewebeschutzhülse, Dynafix.....	154		
Gewebeschutzhülse, Hohlschrauben.....	67		
Gewindeschneider für Hohlschrauben.....	67		
Gewindeschneider Ø 1,5 mm	53		
Gewindeschneider Ø 2,0 mm	53		
Gewindeschneider Ø 2,7 mm	52, 128, 141		
Gewindeschneider Ø 3,5 mm	34, 128, 141		
Gewindeschneider Ø 4,5 mm	11		
Gewindeschneider Ø 6,5 mm	11		
Gewindeschneider, DMS	88		
Gewindeschneider, DMS Intermediate	98		
Gleitlochbohrer Ø 2,7 mm.....	127, 140		
Gleitlochbohrer Ø 3,5 mm.....	127, 140		
Griff für Bohrbüchsen	130, 142		
Großfragmentplatten.....	4-9		
Großfragment-System	1-23		
Grundelement Kompression/Distraktion	152		
H			
Hackstock-Flachzange	77		
Halbrohrplatten	4		
Halteklammer	37, 55		
Haltezange für Mini-Platten.....	51, 57		
Handbohrapparate.....	166		
Handgriff FOS	144		
Handgriff für Geweschutzhülsen.....	154		
Handgriff mit Dreibacken-Spannfutter.....	166		
Handstück für AO-Ansatz.....	35, 53, 141		
Handstück für Dental-Ansatz	53		
Hohlschrauben.....	64, 65		
Hohlschrauben-System	63-69		
Hohmann mini, Knochenhebel.....	3, 32		
Humerus-Platte.....	125		
I			
Inbus-Klingen	169		
Inbus-Schlüssel Ø 5 mm.....	155		
Instrumente Großfragment-Set.....	22		
Instrumente Kleinfragment-Set.....	42		
Instrumente Minifragment-Set.....	60		
ISIS-Biegezange.....	130		
ISIS-Platten	125		
ISIS-Schränkeisen	126		
ISIS-System	123-133		
ISIS-Tiefenmesser	131		
ISIS-Zentrierhülsen	126		
J			
Jacobs Bohrfutter	168		
K			
Kanülierte Eindreh Schlüssel	67		
Kanülierte Kortikalisfräser	66		
Kanülierte Vorbohrer	66		
Kanüliertes Schrauben-System	63-69		
Kardanschlüssel 11 mm	15		
Kardanschlüssel Ø 5 mm	155		
K-Drähte	72		
K-Drahtspender	80, 81		
Kernlochbohrer Ø 2 mm.....	127, 131, 140		
Kernlochbohrer Ø 2,5 mm.....	127, 131, 140		
Kirschner Extensionsbügel	161, 162		
Kirschner-Drähte	72		
Klavikula-Platte.....	125		
Kleeblatt-Platten	29		
Kleinfragmentplatten	29-31		
Kleinfragment-System	25-43		
Knochenhalte zange Verbrugge	130		
Knochenhalte zangen	33, 51		
Knochenhebel.....	32, 50		
Knochenhebel Hohmann, mini.....	50		
Kohlefaserstäbe	153		
Kompressionselement, Fixateur	152		
Kompressionsplatten	5, 6, 31, 49		
Kompressionsschrauben.....	87		
Kondylenplatten	102, 107, 138		
Kondylen-Zielgerät	118		
Konischer Fräser	165		
Kopf- und Seitenschneider.....	78		
Kopfraumfräser Ø 1,1 mm	53		
Kopfraumfräser Ø 2,0 mm	34, 52, 141		
Kopfraumfräser Ø 3,2 mm	10		
Kopfraumfräser Ø 4,5 mm	10		
Kopfschneider.....	75		
Kortikalisfräser für Hohlschrauben	66		
Kortikalisschraube Ø 1,5 mm	46		
Kortikalisschraube Ø 2,0 mm	46		
Kortikalisschraube Ø 2,7 mm	46, 124		
Kortikalisschraube Ø 3,5 mm	26, 27, 124		
Kortikalis-Schrauben Ø 4 mm.....	87		
Kortikalis-Schrauben Ø 4,5 mm.....	2, 95		
Kreuzplatten	9		
Kreuzschlitz-Ansatz	168		
Kugelfräser	164		
L			
L-Abstützplatten.....	8		
Löffelplatten	7		
L-Platten	48, 49		

M			
Mädchenfänger	163	Schraubenpinzetten.....	2, 37, 55
Malleolarschrauben Ø 4,5 mm.....	2, 64	Schulter-Hakenplatte	125
Martin-Diamant Kopfschneider	75	Schulter-Plattensystem	123-133
Mehrfach-Bohrdrahtspender	80	Schwarz-Drahtbiegezange.....	76
Mehrfragmentplatten	47, 48	Seitenschneider	75, 77, 78
Messhülse DMS	88	Sitzinstrumente.....	116
Messhülse DMS Intermediate	97	Spannschlüssel	161
Mini-Bohrlehre Ø 1,1/1,5 mm	54	Spiralbohrer.....	164
Minifragmentplatten	47-49	Spiralbohrer Ø 1,1 mm	52
Minifragment-System	45-61	Spiralbohrer Ø 2 mm	52
Mini-Kompressionsschrauben	95	Spiralbohrer Ø 1,5 mm	34, 52
Mini-Kopfraumfräser Ø 1,1 mm	53	Spiralbohrer Ø 2,5 mm	34, 96
Mini-Platten.....	48, 49	Spiralbohrer Ø 2,7 mm	52
Mini-Plattenhaltezeuge	51, 57	Spiralbohrer Ø 3,2 mm	10, 91, 96
Mini-Schraubenmessgerät	54	Spiralbohrer Ø 3,5 mm	34
Montageelemente, Fixateur	152	Spiralbohrer Ø 4,5 mm	10, 91
Montiertes Gelenk, komplett.....	150	Spiralbohrer, Dynafix	154
Mutter Ø 11 mm	2	Spitzfräser	165
		Spongiaschraube Ø 3,5 mm	26, 27
		Spongiaschraube Ø 4,0 mm	28
		Spongiaschrauben Ø 6,5 mm	3
		Stahldraht, weich	72
N		Standard-Schrauben Ø 2,7 mm	124, 136
Nachschlaginstrument	117	Standard-Schrauben Ø 3,5 mm	124, 136
Navicular-Hohlschrauben Ø 4,0 mm.....	64	Steckbohrbüchse Ø 2,5/2,7 mm	35
		Steckbohrbüchse Ø 3,2 mm	12
		Steinmann-Nägel	153, 160
O			
Ovalfräser	164	T	
		T-Abstützplatten	8
P		T-Drive Schraubendreher	143
Philips-Ansätze	169	T-Drive-Schrauben	124, 136
Platten Großfragment	4-9	T-Griffstück für AO	11, 154
Platten Kleinfragment.....	29-31	T-Handgriff DMS	90, 99
Platten Minifragment.....	47-49	Tibia-Abstützplatten.....	9
Platteneinschläger.....	90, 98	Tiefenmesser.....	128, 131, 143
Plattenfasspinzette	143	Tiefenmesser, groß.....	13, 91
Plattenhalteinstrumente.....	131, 142	Tiefenmesser, klein.....	96
Plattenhaltezeuge.....	51	Titan-Schrauben.....	124, 136
Plattenschneideinstrument.....	79	Tonnenzange.....	74
Plattensitzinstrumente	116	T-Platten	7, 30, 48, 49
Plattenspanner.....	14	Tragschrauben DMS.....	87
		Tragschrauben DMS Intermediate	95
		Tragschraubendreherhülse DMS.....	89
		Tragschraubendreherhülse DMS Intermediate...97	
		Trephin mit Dorn	165
R			
Raspatorium	32, 50	U	
Ratschenhandgriff	144	Unterlegscheiben Ø 13 mm.....	2, 64, 65
Repositionszangen.....	33, 51	Unterlegscheiben Ø 16 mm.....	65
Röntgenschablone DMS	91	Unterlegscheiben Ø 19 mm.....	65
Röntgenschablone DMS Intermediate.....	99	Unterlegscheiben Ø 7 mm.....	28, 46, 64
Rückfuß-Platten	138, 139	Unterlegscheiben Ø 2,7 mm.....	136
Rückfuß-System.....	135-148	Unterlegscheiben Ø 3,5 mm.....	136
Rundloch-Platten	4, 5	Unterlegscheiben, Titan	136
S		V	
Schanz-Capretto-Schrauben	153	Varisationsosteotomie-Zielgeräte	118, 119
Schanz'sche-Schrauben	153	Verbindungsanker DMS.....	89
Scharfer Haken	13, 37, 55	Verbindungsanker DMS Intermediate.....	97
Schlitz-Ansatz.....	168	Verbrugge Knochenhaltezeuge	130
Schlitzhammer.....	117	Vickers Easidriver™.....	79
Schlüssel für Unterlegscheiben.....	13	Viertelrohrplatten	47
Schmale Kompressionsplatten	49	Vor- und Rückfußsystem	135-148
Schränkeisen	17, 37, 56, 126, 141	Vorböhrer für Hohlschrauben	66
Schrauben und Platten Sets	18, 40, 58	Vorfuß-Platten.....	137
Schraubendreher.....	167		
Schraubendreher Inbus 2,5 mm	36, 53, 99	W	
Schraubendreher Inbus 3,5 mm	13, 89	Weicher Stahldraht.....	72
Schraubendreher ISIS.....	129	Winkelplatten mit Kompressionslöchern .107-113	
Schraubendreher-Einsatz Inbus 1,5 mm	53	Winkelplatten mit Rundlöchern	103-106
Schraubendreher-Einsatz Inbus 2,5 mm	36	Winkelplatten-Instrumente-Set	120
Schraubendreher-Einsatz Inbus 3,5 mm	13		
Schraubendreherklinge T8	144		
Schraubendreherklingen	168, 169		
Schraubendreher-Set	168		
Schraubenmessgerät, klein.....	36, 55		
Schraubenmessgerät, mini	54		

- A**
- Accessories.....159
 - Acromion Clavicle plate (AC)125
 - Aiming device 135°-150° DMS90
 - Aiming device for 130° angle plates.....114
 - Angle plate instrument set120
 - Angle plates.....101-113
 - Angle plates with round holes.....103-106
 - Angular Compression plates107-113
- B**
- Basic unit for compression and distraction.....152
 - BC plate125
 - Bending irons17, 37, 56, 126, 141
 - Bending pliers56, 57, 38, 76
 - Bending press17
 - Bending templates16, 38
 - Bi-cortical plate, ISIS125
 - Böhler wire traction bow160
 - Bone holding forceps33, 51
 - Bone holding forceps Verbrugge.....130
 - Bone lever Hohmann mini50
 - Bone levers.....32, 50
 - Bone wire guides.....76
 - Burrs.....164, 165
- C**
- Cancellous screw Ø 3.5 mm26, 27
 - Cancellous screw Ø 4.0 mm28
 - Cancellous screws Ø 6.5 mm.....3
 - Cannulated cortical reamers66
 - Cannulated drill bits66
 - Cannulated hexagonal keys.....67
 - Cannulated screw set.....68
 - Cannulated screws63-65
 - Carbon-fibre rods.....153
 - Cardan wrench Ø 11 mm15
 - Cardan wrench Ø 5 mm155
 - CC plates.....125
 - Centering sleeves88, 126
 - Cerclage system71, 82
 - Chinese finger traps.....163
 - Clavicle plate125
 - Clip for plateholding55
 - Cloverleaf plates.....29
 - Combination cutting pliers78
 - Combo reamers88, 98
 - Compression plates5, 6, 31, 49
 - Compression screws87
 - Compression unit, fixator152
 - Condylar plate guide.....118
 - Condylar plates102
 - Condylar plates with compression holes.....107
 - Conical burr.....165
 - Core hole drill Ø 2.0 mm127, 131, 140
 - Core hole drill Ø 2.5 mm127, 131, 140
 - Cortex screw Ø 1.5 mm.....46
 - Cortex screw Ø 2.0 mm.....46
 - Cortex screw Ø 2.7 mm.....46, 124
 - Cortex screw Ø 3.5 mm.....26, 27, 124
 - Cortex screws Ø 4.5 mm2
 - Cortical reamer for cannulated screws66
 - Cortical screw Ø 4.5 mm.....95
 - Cortical screws Ø 4 mm87
 - Countersink Ø 1.1 mm.....53
 - Countersink Ø 2 mm.....34, 52, 141
 - Cross-tip bit.....168
 - Cylindrical burr165
- D**
- Dental handle53
 - Depth gauge, large13, 91
 - Depth gauge, mini54
 - Depth gauge, small.....36, 55, 96
 - Depth gauges.....128, 131, 143
 - Distraction unit, fixator152
 - DMS plates.....86
 - DMS85-100
 - DMS aiming device90
 - DMS centering sleeve88
 - DMS Combo reamers88
 - DMS compression screws.....87
 - DMS guide wire Ø 2.5 mm88
 - DMS Intermediate combo reamer.....98
 - DMS Intermediate compression screw95
 - DMS Intermediate guide wire Ø 2.0 mm.....97
 - DMS Intermediate lag screw connector.....97
 - DMS Intermediate lag screw inserter.....97
 - DMS Intermediate lag screws95
 - DMS Intermediate measuring sleeve97
 - DMS Intermediate plate impactor98
 - DMS Intermediate plates94
 - DMS Intermediate safety inserter.....97
 - DMS Intermediate Set100
 - DMS Intermediate tap98
 - DMS Intermediate X-ray template99
 - DMS lag screw connector89
 - DMS lag screws.....87
 - DMS measuring sleeve.....88
 - DMS plate impactor.....90
 - DMS Plates.....86
 - DMS safety inserter for screwdriver89
 - DMS screwdriver89
 - DMS tap.....88
 - DMS T-handle99
 - DMS X-ray template.....91
 - Doyen spherical burr.....165
 - Drill bit for cannulated screws66
 - Drill bit guide and sleeve Ø 2 mm.....35, 54
 - Drill bit guide for 25-212-4512
 - Drill bit guide inserts130, 142
 - Drill bit guide neutral/eccentric Ø 2.5 mm.36, 96
 - Drill bit guide, neutral/eccentric 2 mm56
 - Drill bit guide, neutral/eccentric Ø 3.2 mm.15, 91
 - Drill bit Ø 1.1 mm.....52
 - Drill bit Ø 1.5 mm.....52
 - Drill bit Ø 2 mm.....34, 52
 - Drill bit Ø 2.5 mm.....34, 96
 - Drill bit Ø 2.7 mm.....52
 - Drill bit Ø 3.2 mm.....10, 91, 96
 - Drill bit Ø 3.5 mm.....34
 - Drill bit Ø 4.5 mm.....10, 91
 - Drill bit sleeve for compression holes114
 - Drill bit sleeve for round-hole and semitubular plates.....14
 - drill bit sleeve for round-hole plates114
 - Drill bit sleeve Ø 1.1/1.5 mm54
 - Drill bit sleeve Ø 2.5/2.7 mm35
 - Drill bit sleeve Ø 3.2 mm for 25-212-45-01.....12
 - Drill guide for Plate tensioner14
 - Drill guide Ø 2.7 mm.....126
 - Drill guide Ø 3.5 mm.....126, 142
 - Drills.....164
 - Drills, Dynafix154
 - Dynafix.....149-158
 - Dynafix combi instrument Ø 5 mm.....155
 - Dynafix® Sets.....156, 158
- E**
- EasyCut.....78
 - Explantation screwdriver129
 - External fixator149-158
 - Extracting forceps77
 - Extractor117
- F**
- Flat drill bit164
 - Flat nose pliers74, 77
 - Flat trephine.....165
 - Flat-tip bit168
 - Forefoot plates (FOS).....137
 - FOS Fore- and Hindfoot system135-148
- G**
- Gliding hole drill Ø 2.7 mm.....127, 140
 - Gliding hole drill Ø 3.5 mm.....127, 140
 - Guide wire Ø 2.0 mm97
 - Guide wire Ø 2.5 mm88
 - Guide wires for cannulated screws66
- H**
- Hackstock flat nose plier.....77
 - Hand drills166
 - Handle.....144
 - Handle for AO attachment.....35, 53, 141
 - Handle for dental attachment53
 - Handle for drill bit guides130, 142, 154
 - Handle with three jaw chuck166
 - Hex wrench Ø 5 mm.....155
 - Hexagonal key for cannulated screws67
 - Hexagonal wrench169
 - Hindfoot plates138, 139
 - Hindfoot system135-148
 - Hohmann mini. bone lever32, 50
 - Holding forceps for mini plates.....51, 57
 - Hollow screws63-68
 - Humerus plate125
- I**
- Impactor117
 - Inserter117
 - Inserter – extractor117
 - Instruments large fragment set22
 - Instruments mini fragment set.....60
 - Instruments small fragment set42
 - ISIS bender-cutter.....145
 - ISIS bending iron126
 - ISIS bending pliers.....130
 - ISIS bending tools.....143, 145
 - ISIS centering sleeves126
 - ISIS depth gauge131
 - ISIS plates125
 - ISIS system123-133
- J**
- Jacobs chuck.....168
 - Joints, fixator.....150,151
- K**
- Kirschner wire traction bow161,162
 - Kirschner wires72
 - Kondylar plates138
 - K-wire dispensers80, 81
 - K-wires.....72
- L**
- Lag screw connector, DMS89
 - Lag screw connector, DMS Intermediate97
 - Lag screw inserter, DMS.....89
 - Lag screw inserter, DMS Intermediate97
 - Lag screws, DMS.....87
 - Lag screws, DMS Intermediate95
 - Large fragment plates4-9
 - Large fragment system.....1-23
 - L-Buttress plates.....8
 - Locking cortical screws124
 - L-plates.....48, 49

- M**
- Malleolar cannulated screws Ø 4.5 mm64
 - Malleolar countersinks10
 - Malleolar screws Ø 4.5 mm2
 - Martin-Diamant wire nippers75
 - Measuring sleeve, DMS88
 - Measuring sleeve, DMS Intermediate97
 - Mini Compression Screw Ø 3.5 mm95
 - Mini depth gauge54
 - Mini drill bit sleeve Ø 1.1/1.5 mm54
 - Mini fragment plates47-49
 - Mini fragment system45-61
 - Mini plates48, 49
 - Mini-countersink Ø 1.1 mm53
 - Mini-plate holding forceps51, 57
 - Mounted joint, complete150
 - Mounting elements, fixator152
 - Multi fragment plates47, 48
 - Multiple K-wire dispenser80
- N**
- Navicular cannulated screws Ø 4.0 mm64
 - Nut Ø 11 mm2
- O**
- One-third tubular plates29
 - Open-ended wrench 11 mm15
 - Oval burr164
- P**
- Periosteal elevator, small32, 50
 - Philips-attachments169
 - Plate bending pliers16, 130, 144
 - Plate cutter79
 - Plate holding forceps51, 143
 - Plate holding instruments131, 142
 - Plate impactor90, 98
 - Plate tensioner14
 - Plateholding clip37
 - Plates large fragment4-9
 - Plates mini fragment47-49
 - Plates small fragment39-31
 - Plug-in drill bit guides130, 142
 - Pointed burr165
 - Positioning plates118, 119
- Q**
- Quarter-tubular plates47
- R**
- Ratchet handle for screwdriver bit144
 - Reamer Ø 4 mm115
 - Reduction forceps33, 51
 - Round hole plates4, 5, 13
- S**
- Safety inserter, DMS89
 - Safety inserter, DMS Intermediate97
 - Schanz screws153
 - Schanz-Capretto screws153
 - Schwarz wire bending pliers76
 - Screw driver Hexagon 2.5 mm36, 53, 99
 - Screw driver Hexagon 3.5 mm13, 89
 - Screw forceps2, 37, 55
 - Screwdriver167
 - Screwdriver bit Hexagon 1.553
 - Screwdriver bit Hexagon 2.536
 - Screwdriver bit Hexagon 3.513
 - Screwdriver bit T8144
 - Screwdriver bits168, 169
 - Screwdriver ISIS129
 - Screwdriver set168
- Screws and plates sets18, 40, 58
 - Seating chisels116
 - Seating instruments116
 - Semi-tubular plates4
 - Sharp hook13, 37, 55
 - Shoulder hook plate125
 - Shoulder plate system123-133
 - Side-cutting pliers75, 77, 78
 - Single K-wire dispenser81
 - Sliding guide for seating chisel115
 - Slotted hammer117
 - Small compression plates49
 - Small fragment plates39-31
 - Small fragment system25-43
 - Soft steel wire72
 - Soft tissue sleeve Ø 4.5 mm12, 90
 - Soft-tissue protection sleeve f. angle plates114
 - Soft-tissue sleeve and drill bit guide
 - Ø 2.5/3.5 mm35
 - Soft-tissue sleeve for cannulated screws67
 - Soft-tissue sleeve for drill bit Ø 3.5 mm12, 54
 - Soft-tissue sleeve Ø 2.7 mm126, 142
 - Soft-tissue sleeve Ø 3.5 mm126, 142
 - Soft-tissue sleeves, Dynafix154
 - Special hip compression plates9
 - Spherical burr164
 - Spoon plates7
 - Standard screws Ø 2.7 mm124, 136
 - Standard screws Ø 3.5 mm124, 136
 - Steel wire, soft72
 - Steinmann pins153, 160
- T**
- Tap Ø 1.5 mm53
 - Tap Ø 2.0 mm53
 - Tap Ø 2.7 mm52, 128, 141
 - Tap Ø 3.5 mm34, 128, 141
 - Tap Ø 4.5 mm11
 - Tap Ø 6.5 mm11
 - Tap, DMS88
 - Tap, DMS Intermediate98
 - Taps for cannulated screws67
 - T-Buttress plates8
 - T-Drive screwdriver143
 - T-Drive screws124, 136
 - T-handle DMS90, 99
 - T-handle for AO attachment11, 154
 - Three-jaw chuck168
 - Tibia buttress plates9
 - Titanium screws124, 136
 - T-plates7, 30, 48, 49
 - Traction hook for extention bows163
 - Trephine with mandrel165
 - Twist drills164
- V**
- Verbrugge bone holding forceps130
 - Vickers Easidriver™79
 - Vise grip74
- W**
- Washers Ø 13 mm2, 64, 65
 - Washers Ø 16 mm65
 - Washers Ø 19 mm65
 - Washers Ø 2.7 mm136
 - Washers Ø 3.5 mm136
 - Washers Ø 7 mm28, 46, 64
 - Washers, Titanium136
 - Wire bending pliers76
 - Wire cerclage system71
 - Wire cutter78
 - Wire dispensers80, 81
 - Wire guide67
 - wire mesh, autoclavable163
 - Wire nippers75
 - Wire set82
 - Wire strainer161
 - Wire traction bow Böhrler160
 - Wire traction bow Kirschner161, 162
 - Wire Traction Bow Portfolio160-163
 - Wire twisting forceps74
 - Wrench162
 - Wrench for washer13
- X**
- X-ray template DMS91
 - X-ray template DMS Intermediate99
- Z**
- Z-plates47

KLS Martin Group

Karl Leibinger Medizintechnik GmbH & Co. KG
78570 Mühlheim · Germany
Tel. +49 7463 838-0
info@klsmartin.com

KLS Martin GmbH + Co. KG
79224 Umkirch · Germany
Tel. +49 7665 9802-0
info@klsmartin.com

Stuckenbrock Medizintechnik GmbH
78532 Tuttlingen · Germany
Tel. +49 7461 165880
verwaltung@stuckenbrock.de

Rudolf Buck GmbH
78570 Mühlheim · Germany
Tel. +49 7463 99516-30
info@klsmartin.com

KLS Martin France SARL
68000 Colmar · France
Tel. +33 3 8921 6601
france@klsmartin.com

Martin Italia S.r.l.
20871 Vimercate (MB) · Italy
Tel. +39 039 605 6731
italia@klsmartin.com

Martin Nederland/Marned B.V.
1271 AG Huizen · The Netherlands
Tel. +31 35 523 4538
nederland@klsmartin.com

KLS Martin UK Ltd.
Reading RG1 3EU · United Kingdom
Tel. +44 1189 000 570
uk@klsmartin.com

Nippon Martin K.K.
Osaka 541-0046 · Japan
Tel. +81 6 62289075
nippon@klsmartin.com

KLS Martin L.P.
Jacksonville, FL 32246 · USA
Tel. +1 904 641 7746
usa@klsmartin.com

Gebrüder Martin GmbH & Co. KG
Representative Office
121471 Moscow · Russia
Tel. +7 499 792-76-19
russia@klsmartin.com

Gebrüder Martin GmbH & Co. KG
Representative Office
201203 Shanghai · China
Tel. +86 21 2898 6611
china@klsmartin.com

Gebrüder Martin GmbH & Co. KG
Representative Office
Dubai · United Arab Emirates
Tel. +971 4 454 16 55
middleeast@klsmartin.com

1923 | SURGICAL
2013 | INNOVATION
YEARS

Gebrüder Martin GmbH & Co. KG
A company of the KLS Martin Group
KLS Martin Platz 1 · 78532 Tuttlingen · Germany
Postfach 60 · 78501 Tuttlingen · Germany
Tel. +49 7461 706-0 · Fax +49 7461 706-193
info@klsmartin.com · www.klsmartin.com

